

Acoustical horns and waveguides

Jean-Michel Le Cléac'h

ETF 2010

Stella Plage, Saturday November 27

toutes illustrations droits réservés sauf spécifié

Horns

etymology: Greek : karnon,
Latin : cornu.

the *horn* of an animal

a "wind instrument"
(originally made from animal horns)

reference to car horns is first recorded in
1901.

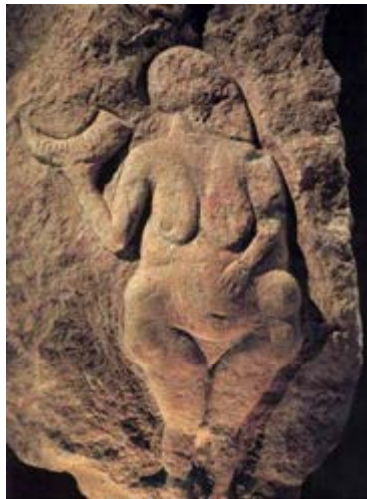

Neolithic carving
Laussel cave, France



cornucopia

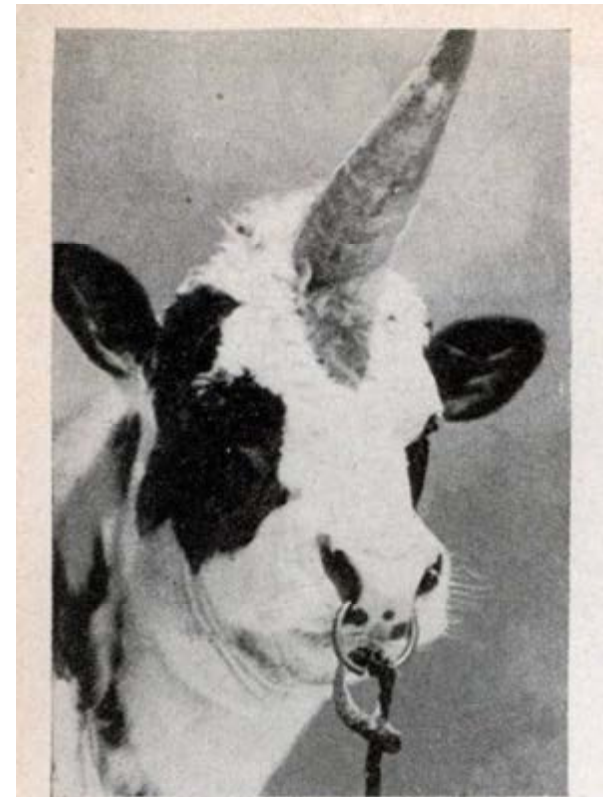

**BULL WITH SINGLE HORN
IS MODERN UNICORN**

WHAT might be called a modern unicorn has been produced by Dr. W. F. Dove, University of Maine biologist. From a day-old bull calf, Dr. Dove removed the two small knots of tissue which normally develop into horns. These horn buds he transplanted in the center of the bull's forehead, thereby inducing the growth of a single massive horn. The bull, now nearly three years old, has developed much of the proud bearing ascribed to the mythical unicorn.

Pavillon de l'oreille, pavillon acoustique (in French)



Etymology of the french name « pavillon »:

Pavillon de l'oreille = part of the external ear which looks like a butterfly
(butterfly = « *papillio* » in latin, « *papillon* » in french)

An automatic translation may also lead to surprising results like "small house" or "flag"... 3

Definition

a horn is a tube whose cross-section increases from throat to mouth in order to increase the overall efficiency of the driving element = the diaphragm. The horn itself is a passive component and does not amplify the sound from the driving element as such, but rather improves the coupling efficiency between the speaker driver and the air. The horn can be thought of as an "acoustic transformer" that provides impedance matching between the relatively dense diaphragm material and the air which has a very low density.

This is important because the difference in densities and motional characteristics of the air and of the driving element is a mismatch. The part of the horn next to the speaker cone "driver" is called the "throat" and the large part farthest away from the speaker cone is called the "mouth".

Historical milestones

1876 _____ Bell's Telephone 

1877 _____ Edison's Phonograph 

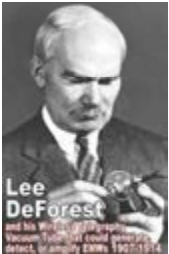
1906 _____ Lee de Forest's triode 

1920 _____ first commercial radio broadcast 

1920 _____ first commercial electrical recording 

1926 _____ First commercial talking movie 

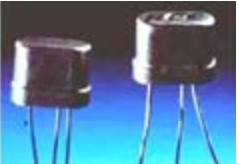
1953 _____ Transistor commercialization 



Oliphant

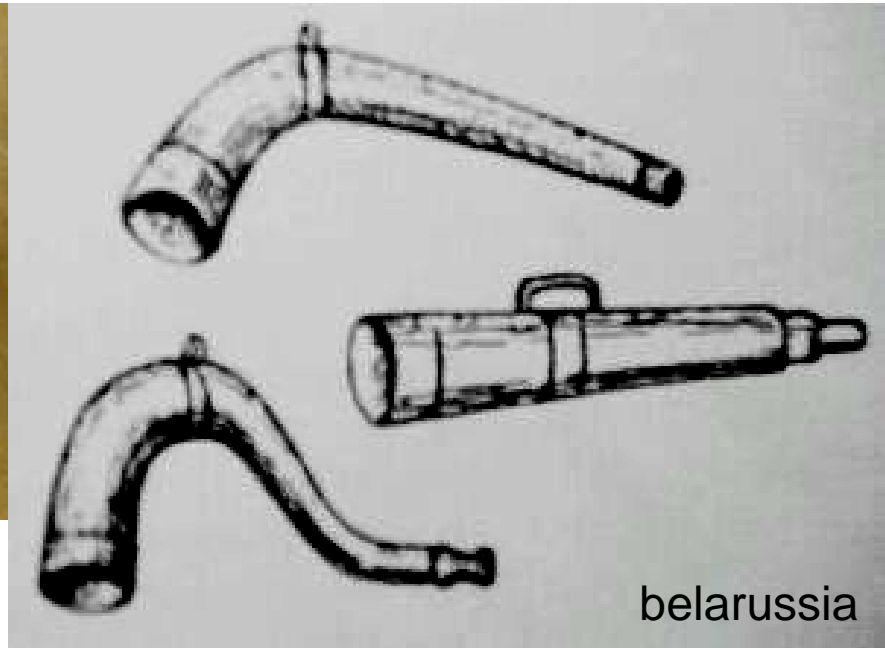

belarussia

The Hornblower of Bainbridge 1898



James Horner who died in 1899



Shofar horn



Hunting Horn

The First Horns

Like the simple wooden flute, the bull's horn has been with us for a very long time. We know from ancient accounts that the horn was used to communicate over long distances, but how far a distance? In the aeons before the sort of background noise pollution we have all become accustomed to, the sound of a horn could be heard for miles. As well, sound carries over water- so well, in fact, that on a calm evening, while on the water, normal conversation may carry up to half a mile. And the reflective properties of hillsides and mountains can sometimes carry the

sound of a horn a good ten miles and more!

How was a bull's horn used in hunting? There were two ways. No one is certain which of these characteristics came first but the bull's horn was used by hunters to pass on needed information in the conducting of the hunt. As well.



Carved Conque Shell from Nepal with the Goddess Kharaccheri in a Mandala.



India



Turbinella Pyrum



Tahitian Pu-Toka

megaphones



Fisherman using a megaphone



Echo Lake megaphone



Giant megaphone in Brussels



And now she beats her heart, whereat it groans,
That all the neighbour caves, as seeming troubled,
Make verbal repetition of her moans;
Passion on passion deeply is redoubled:
'Ay me,' she cries, and twenty times, 'Woe, woe',
And twenty echoes twenty times cry so.

« *Venus and Adonis* », Shakespeare

horns as music instruments

- First horns
 - China
 - Oxus
 - Egypt
 - Greece
- Alphorns and thibetan horns
- Brass instruments
- Strings instruments with horns

First trumpets :

- 4000 BC in China
- 3000 BC in OXUS (Afghanistan-Russia frontier)
- 1500 BC in Egypt
- 300 BC in Greece
- 300 BC in America



Oxus civilization

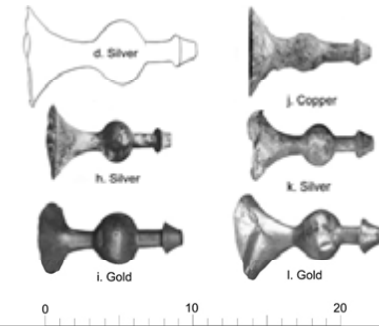
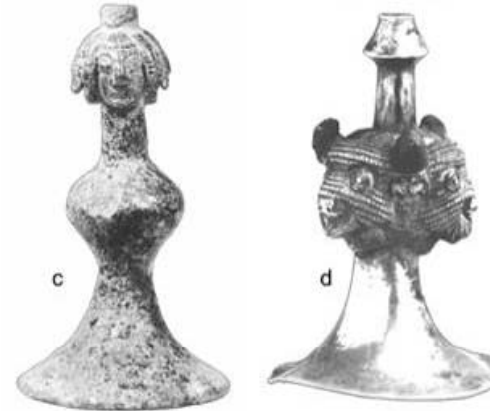

ancient Greece

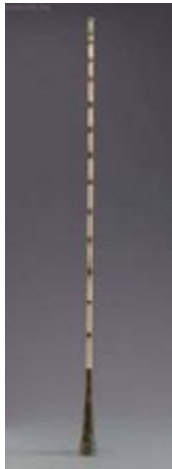

greek *salpinx*



Tutankhamun's trumpets



Trumpet
Egyptian Trumpet



"tuuut.....!"



ancient Egypt



Thibetan horn

Tibetan horn



One of the oldest musical instruments still in use today is the Alphorn,

Mouthpiece

Body
Split wood covered in rattan (palm stems).

Alphorn

Cowherds use the alphorn to signal to each other across alpine pastures. It has also been used to summon communities to church, or to war.

Bell
Formed from the part of the tree that curves upward from the roots.

THE ALPHORN is one of the largest trumpets. It is used in many high mountain regions, particularly in Switzerland. The alphorn is usually made out of mountain trees such as young firs, lime trees, or poplars. They are split in half and hollowed out. The halves are rejoined and bound with bark strips, rattan, or gut.

This odd instrument produces tones like those from a cello

Horns Made from Tree Trunks Give Odd Musical Tones

HORNS hollowed out of tree trunks are used by native musicians in the Tyrol region of Austria. The novel instruments, said to imitate the tone of a cello, are fitted with stops so that they can play all the notes of the scale. Tree bark is left on the horns in the belief that it has a softening effect on the tones of the instruments.

A small group of Tyrolese musicians playing on their wooden horns



Brass instruments from the 19th



METZLER 1860

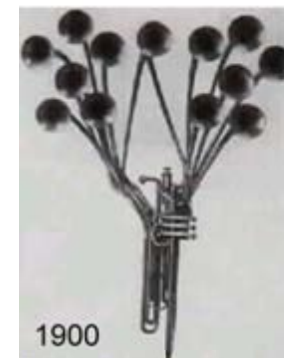

1900



The World's Largest Saxophone

THERE is plenty of music in this horn. Standing six feet, seven inches in height, this saxophone is believed to be the largest in the world. In spite of its height it may be played from a sitting position—provided the musician is sufficiently expert.



A tripod support is needed for this saxophone.

BRASS HORN TWELVE FEET LONG PLAYED BY SIX MIDGETS

Measuring 12 feet in length, a giant horn requires at least two men to play it, as it is so cumbersome that one person cannot carry it. Recently, at a convention in the South, six midget men were necessary to handle the instrument: one at the mouth-



Massive Brass Instrument that Is Played by Two Midgets while Four Others Hold It

piece, another at the keys, and four to support it. This huge band piece was made in Paris and brought to this country about 75 years ago.



brass horn used to load a loudspeaker by Susumu Sakuma

127dB!



vuvuzela

Vuvuzela: Should the horn be banned from the World Cup?

June 14, 2010 10:00 AM
By PCV



A young soccer fan with a Vuvuzela horn. (Sebastian Illow/Associated Press)

It's the horn heard around the world, broadcast into living rooms and bars as people tune into the 2010 FIFA World Cup. The vuvuzela, a stadium horn popular with South African soccer fans, has become the symbol of this year's tournament, but not everyone is enjoying the festive instrument's loud sounds.

Some fans have called the noise annoying, especially while watching at home, and those closer to the action are concerned about potential hearing damage.

World Cup organizers are even considering a ban on the 127-decibel horn.

What do you think of the vuvuzela? Should it be banned from World Cup matches?

Should the vuvuzela be banned from World Cup games?

- Yes
 No

VoteView Results

Share ThisPollDaddy.com



**Violin with Horn for Sounding Box
Directs Tone toward Audience**

Built on the same principle as a violin and played in the same manner, a musical instrument with a metal horn instead of the usual sounding box has been patented. Each string is provided with a separate bridge and metal diaphragms to amplify the tone. The sound can be focused directly upon those wishing to hear by pointing the mouth of the horn toward them; greater volume is secured, and the tone, while essentially that of a violin, has something of the quality of a cornet's.



**Metal Horn and Diaphragms on This Instrument Give
Violin Tones Resonance and Volume**



violophone



hornviolin



strohviolin

When strings meet horns



strohcello



vioara cu goarna

Non musical purposes

- architectural acoustics
- foghorns
- firemen sirens
- car horns and Klaxon
- military megaphones
- acoustic locators

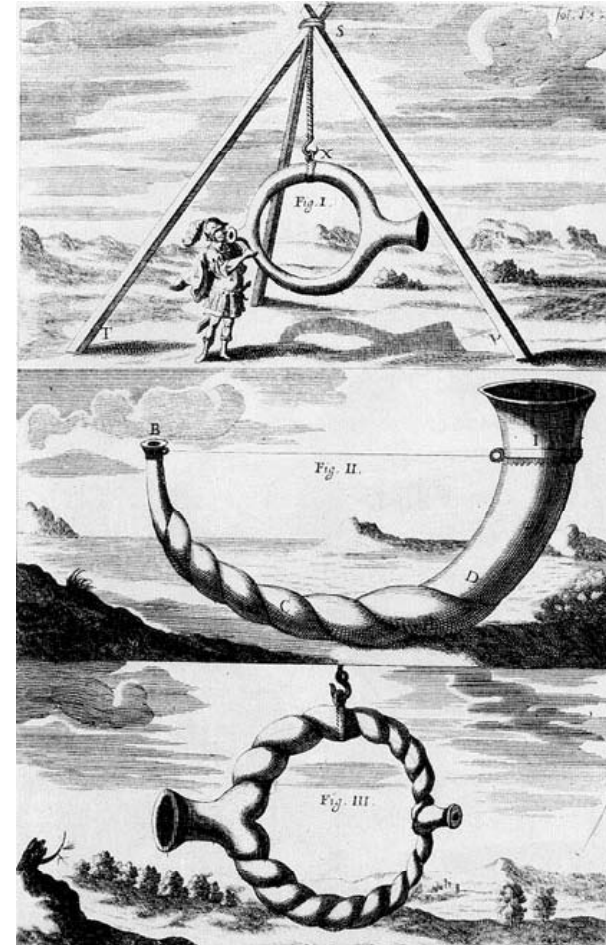

Propagation Horns
in Phonurgia nova
(Kempten 1673)

Architectural purposes

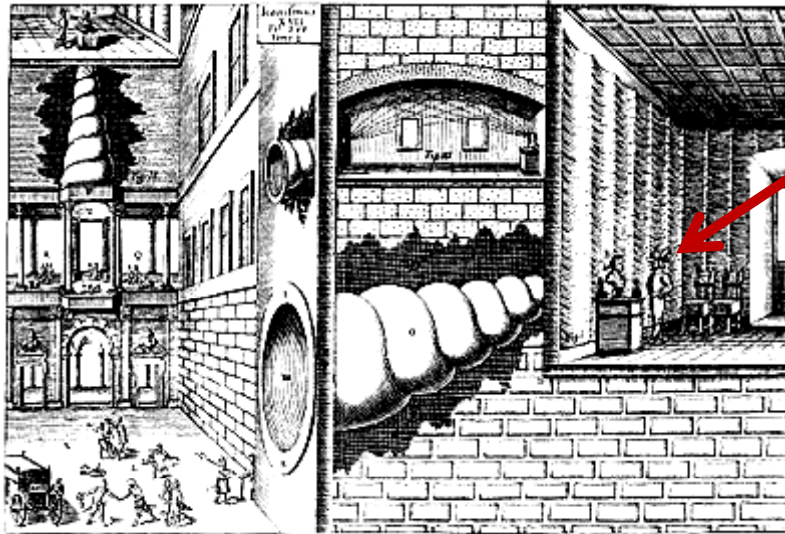

the prince
listening to the
courtiers speaking
outside the
building



P. ATHANASIVS KIRCHERVS FVLIDENSIS
e Societ: Iesu Anno aetatis L.III.
Missa e d'Armanis aq. uisq. in D.D. C. Blonnet Paris a Mai. 8. 1749.

Athanasius Kircher

invented the megaphone
(1608 Germany - 1680 Italy)

Horns used in ancient architecture

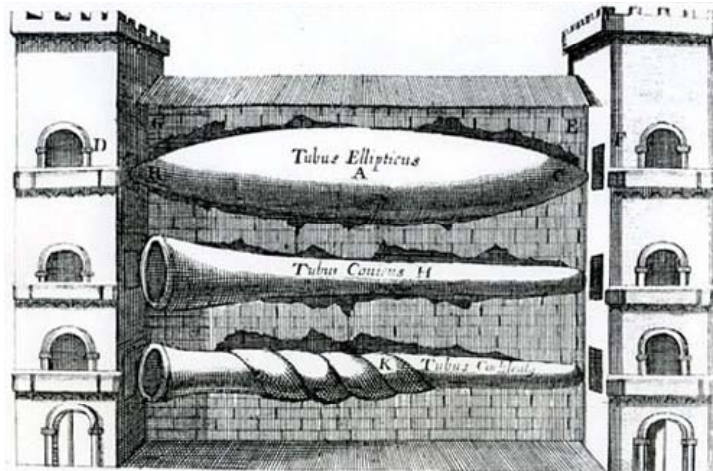

ATHANASIVS KIRCHER - ELLISSI ACUSTICHE CHE CONSENTONO DI COMUNICARE IN SEGRETO
ARS MAGNA LUCI ET UMBRAE (1647)



Today in Mexico



foghorns

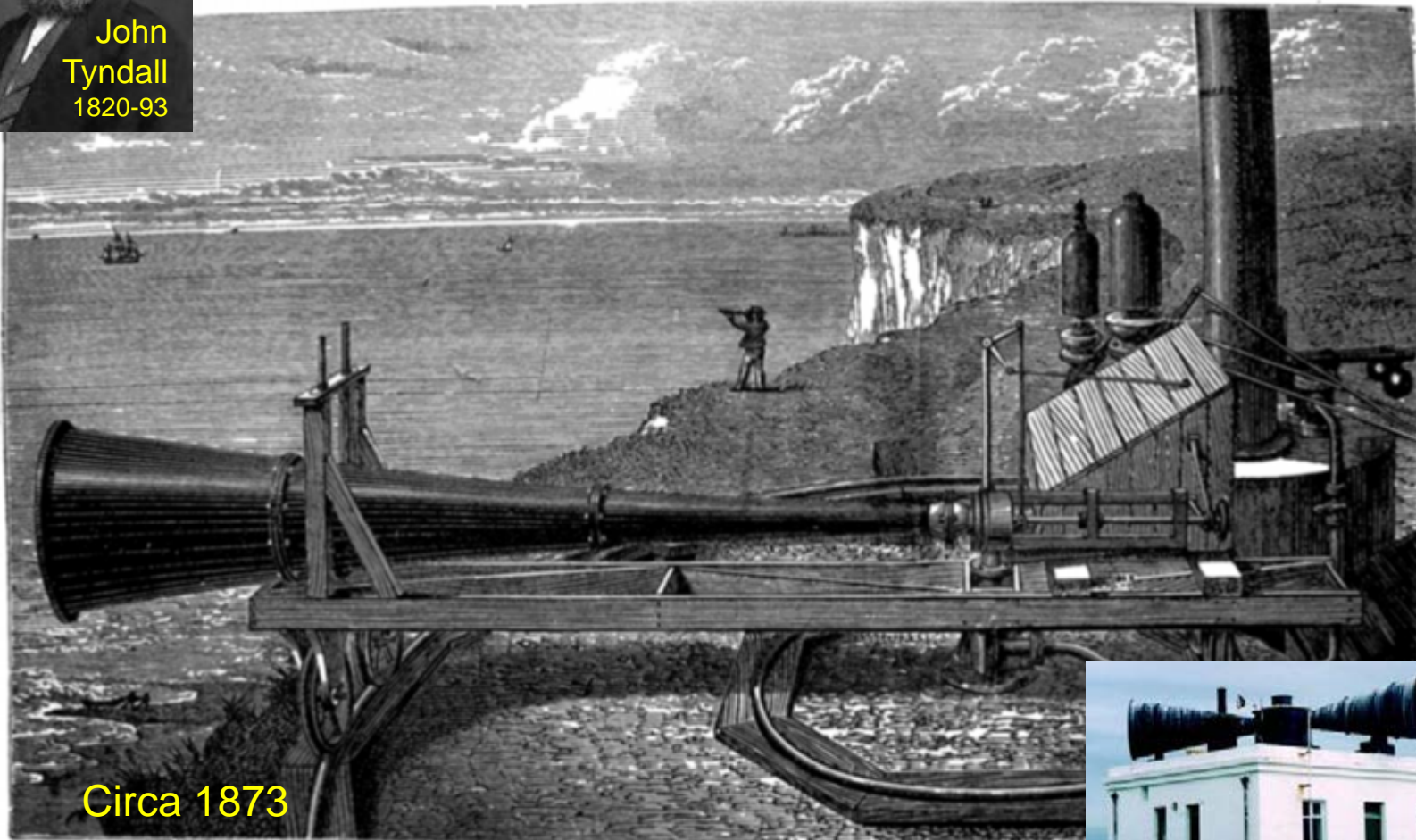
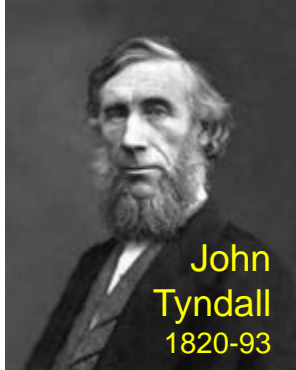

Tyndall's fog-horn



foghorns designed by Lord Rayleigh
Trevose Head Lighthouse, Cornwall (1913)



Firemen siren



AirChime K5LA

Train horns



a siren playing trumpet

sirens and klaxons



Model K-380

Klaxons



Kopenhagen siren



victim of pollution

military megaphones



Bugle Call into Megaphone Gets 'em Up in the Morning



Reveille sounds painfully loud these days to the boys in camp at Fort Jackson, S. C. When the bugler sounds "I can't get 'em up in the morning" he steps to a huge megaphone that blasts his notes throughout the camp. Mess call, he finds, does not require so much artificial amplification.

The bugler at Fort Jackson, S. C., (left) covers plenty of ground with the help of a big megaphone suspended in a frame at his post



before radar:
acoustic locators

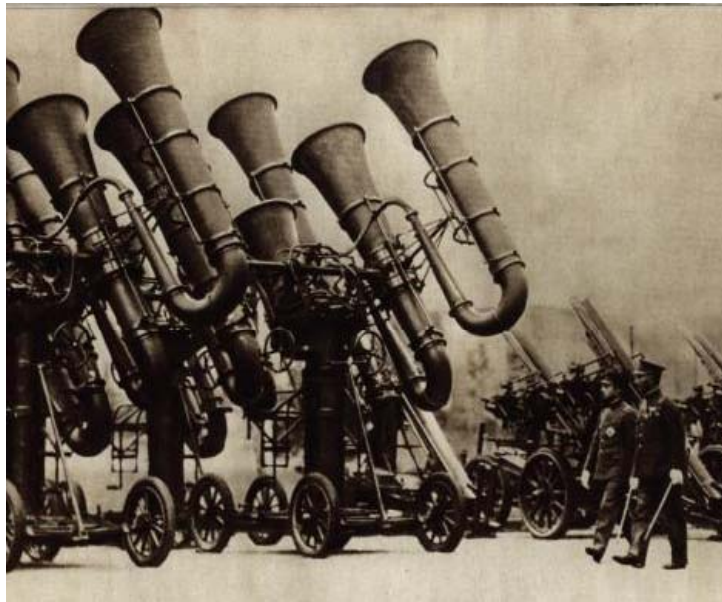
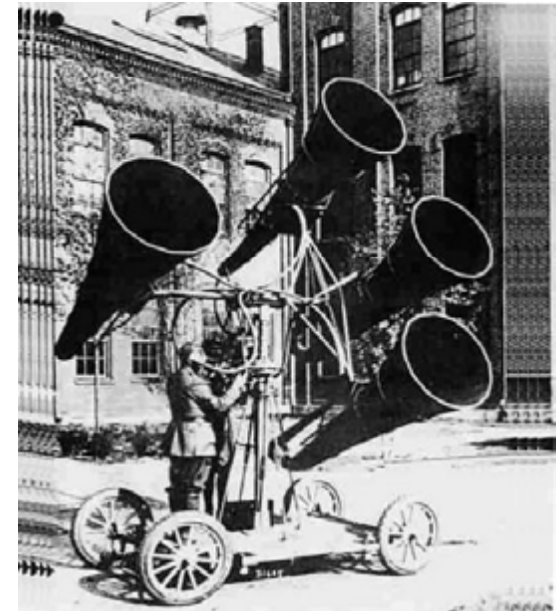

Hearing aids

PHONURGIA, LIBER I. Sect. VII.
PRAGMATIA
 Tuborum Otiorum Constructio
 OMNIS GENERII INSTRUMENTA ACUTICA
 in quibus et commoditas fideliter respicitur.

Quotiesque procedenti bene intellexit, nullum in acuto
 est instrumentum utam generis confectum habet diffi-
 cultatem cum omni cum curatam, quam paratam,
 hyperbolicam, ellipticam et utam proportionem constructam, aut
 hanc applicatam meritiis audientibus. cum tamen tamen effi-
 ciam de cochlearum tubum constructum et quos palmam paratam vi-
 diamus. hoc autem ellipticum tubum O. hoc ingenuo et utam cum
 utam acuticam paratam aut fideliter S. C. utam cum
 utam ingenuo S. V. respondet, et in figura figura apparet.

Fig. 1^a Otia.



Alterum instrumentum est tubum cochlearum, quod ad eam
 paratam habet utam confectum in, utam ad eam compingentem
 cum habet. Figura eam respicit.

Tubus Oticus cochlearum.



Tubus Tertius Oticus.



TECINAS.

In Phonurgia Nova
 Athanasius KIRCHER
 (1673)

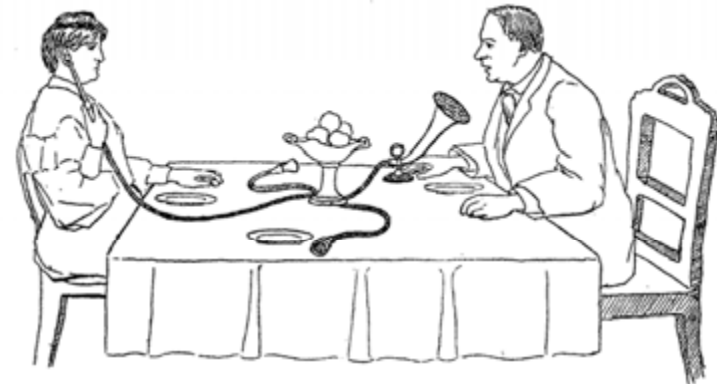

'What, canst thou talk?' quoth she, 'hast thou a tongue?
 O would thou hadst not, or I had no hearing.
 Thy mermaid's voice hath done me double wrong;
 I had my load before, now pressed with bearing;
 Melodious discord, heavenly tune harsh sounding,
 Ears deep sweet music, and heart's deep sore wounding.

Shakespeare

Recording and reproducing sounds

The very first recording of sound was made by Edouard Léon Scott de Martinville with his « phonautographe » before 1857, probably 1854 as written in his writing « *Fixation graphique de la voix* (1857) ». He didn't know how to reproduce those sounds

First successful recording followed by its reproducing (1877) is due to Thomas Alva Edison with his « phonograph ».

Phonautograph

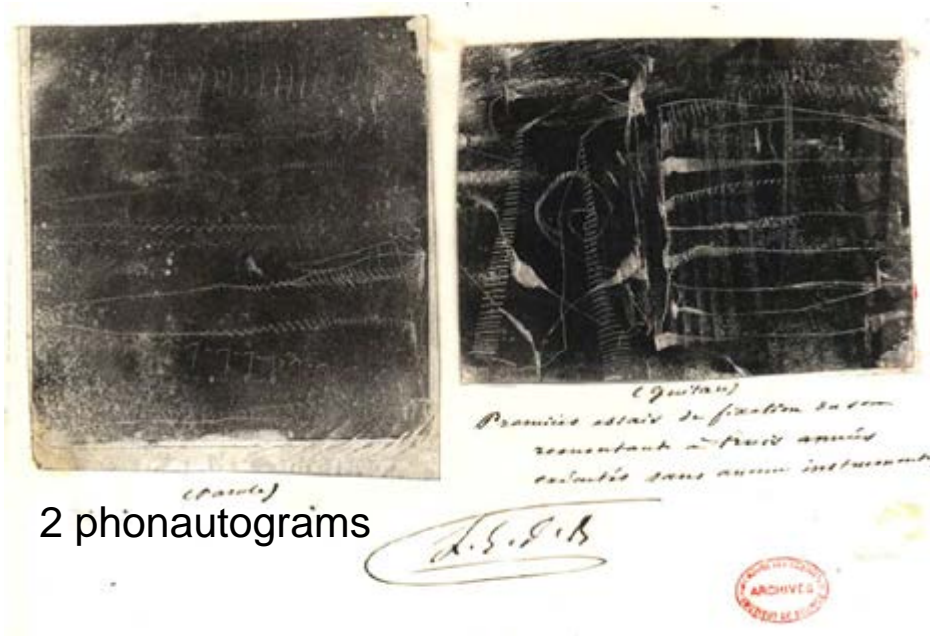

2 phonautograms



The Phonautographic Manuscripts of
ÉDOUARD-LÉON SCOTT DE MARTINVILLE

Edouard Léon Scott



1857
(before Edison)

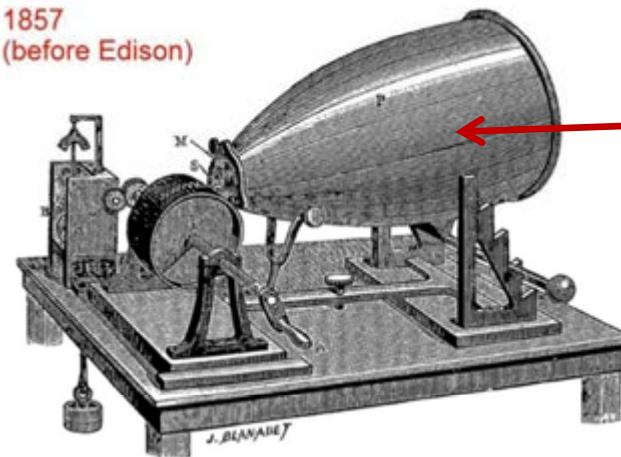

← a simplistic horn

Fig. 11. — Le Phonautographe de Léon Scott de Martinville.

Thomas Alva Edison



In December of 1877, Edison's machinist presented him with the completed prototype.

Edison leaned toward the recording horn and shouted out the words "Mary had a little lamb, it's fleece was white as snow, and everywhere that Mary went, the lamb was sure to go."

It was hardly a moving speech, but then nobody—not even Edison—expected the machine to work the first time.

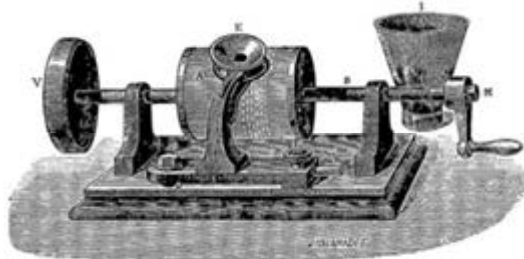

Fig. 20. — Le premier Phonographe d'Edison (1877).

To his great surprise, a highly distorted but recognizable version of Edison's words spilled out of the machine when the tinfoil was cranked under the needle once again.

mary_jas_a_little_lamb.mp3

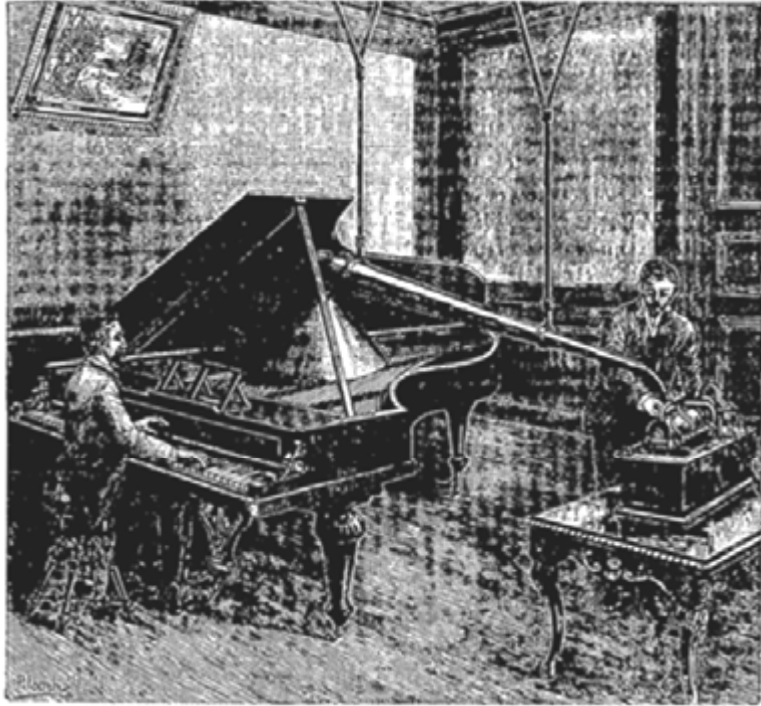

Fig. 21. — Inscription phonographique des sons musicaux.
 recording of a piano on a cylinder



Phonograph
 Victor V, (1907)

Edison Thomas.mp3

at the French Academy

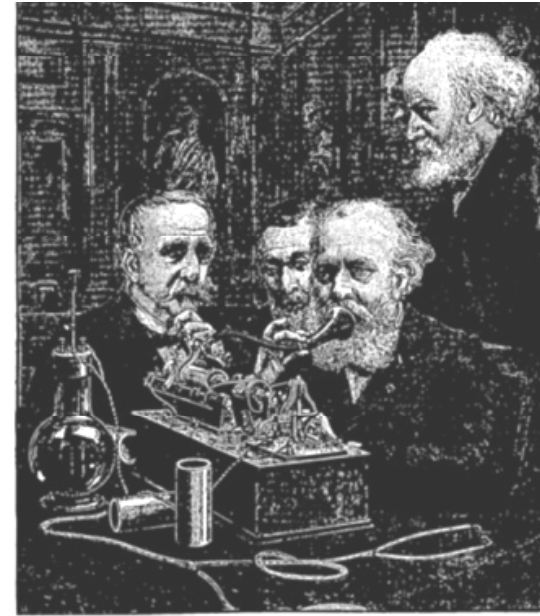

M. le duc d'Angoulême. M. des Clochers. M. Gounod. M. Janssen.
 Fig. 72. — Le Phonographe à la séance de l'Académie des Beaux-Arts (17 avril 1893).

recording at Smithsonian



Phonographe : 1. A cylindres; 2. A disques.

for recording through the horn,
 the head was replaced by a
 "recording head"



Dickson first
 Experimental sound
 film (1894)



making phonographic record at Smithsonian, 3 February 1895

Cylinder version



Disk version



Phonographs

The famous oil painting "His Master's Voice" by Francis Barraud (1895) of the dog Nipper and an Edison-Bell cylinder phonograph, using a horn to load the mechanical transducer to provide the "amplification" necessary to hear the recording.

Phonograph Carried as Vanity Case Plays Standard-Size Records

Carried like a vanity case and about the same size, a collapsible phonograph that plays standard records has been invented.



Portable Phonograph Open to Show Standard-Size Record in Place and Telescoping Horn

The motor is wound by a detachable crank and the horn opens and closes like a telescope so that it can be folded into small space. The entire instrument weighs but little and is said to reproduce tones as satisfactorily as many larger and more expensive machines.



WATCH-CASE PHONOGRAPH

CALLED the world's tiniest talking machine, a miniature phonograph has been built into the case of a watch. When wound by the watch stem, a small spring mechanism turns a midget record. Sound is reproduced through a diminutive horn.





HORN THEORY AND THE PHONOGRAPH

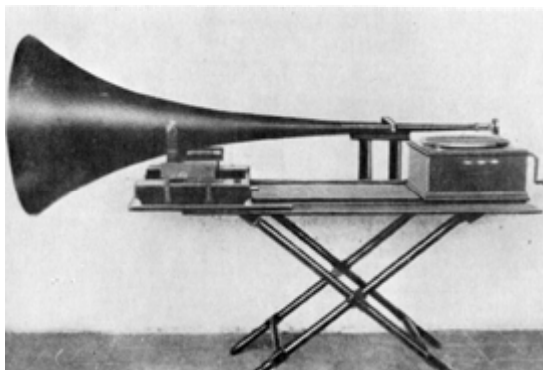

Balmain Gramophone with 5ft. Straight Horn



Percy Wilson



Trapezoidal Horn Fitted to an "Expert" Gramophone

see: « Horn theory and the gramophone »
Percy Wilson in JAES 1974

Electronic tube time

The world's first commercial electrical recording
The setup for Guest and Merriman's pioneering electrical recording of the Burial of the Unknown Soldier in Westminster Abbey on 11 November 1920.

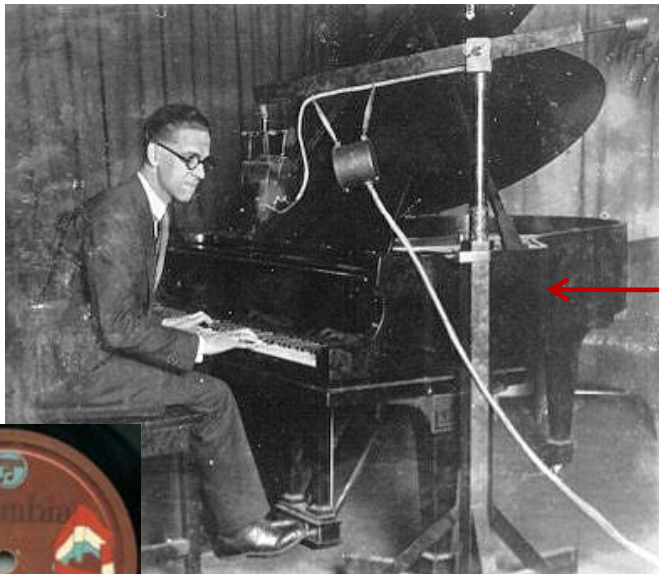
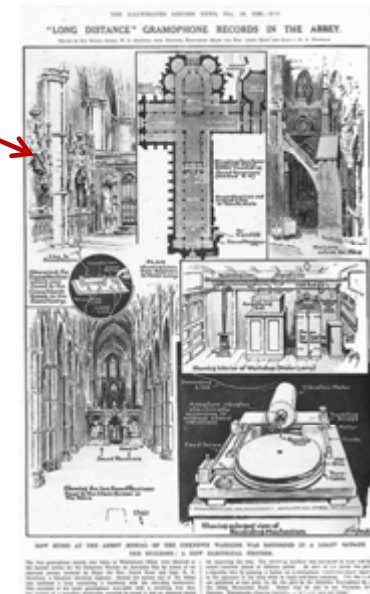

On February 25, 1925, Art Gillham recorded "You May Be Lonesome", a song written by Art Gillham and Billy Smythe.

It was the first master recorded to be released using Western Electric's electrical recording system.





Left, the Radio Truck That Supplies Music to Crowds in Chicago's Parks; Right, Set Built into Refreshment Stand at Luna Park, N. Y.
Left, © P. & A.



Radio times



A Candidate in the French Elections "Stumps" His District by Radio Auto

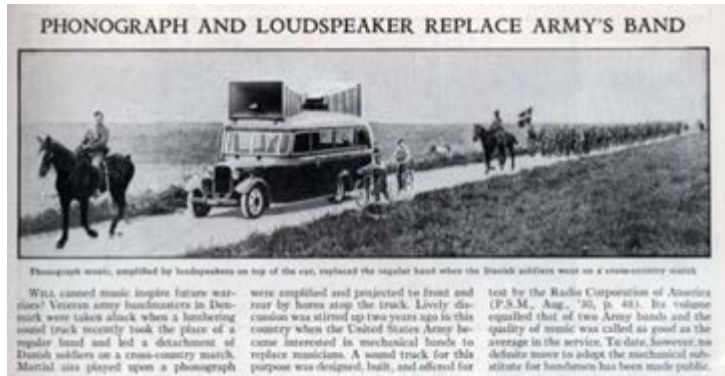

PHONOGRAPH AND LOUDSPEAKER REPLACE ARMY'S BAND



Phonograph music, amplified by loudspeakers on top of the car, replaced the regular band when the Danish soldiers were on a cross-country march. With canned music, inspire future warriors? Veteran army bandmasters in Denmark were taken aback when a lumbering sound truck recently took the place of a regular band and led a detachment of Danish soldiers on a cross-country march. Marcial airs played upon a phonograph were amplified and projected to front and rear by horns atop the truck. Lively discussion was stirred up two years ago in this country when the United States Army became interested in mechanical bands to replace musicians. A sound truck for this purpose was designed, built, and offered for test by the Radio Corporation of America (P.S.M., Aug., '20, p. 48). Its volume equaled that of two Army bands and the quality of music was called as good as the average in the service. To date, however, no definite move to adopt the mechanical substitute for bandmen has been made public.



1920

In Pittsburgh, Westinghouse radio station KDKA schedules the first commercial radio broadcast—the Harding-Cox presidential election results.



The first radio broadcast microphone

a question of conversion efficiency of the energy

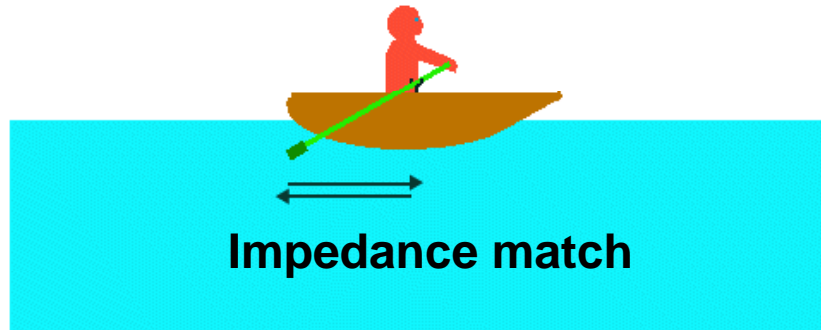

A boat at the interface between air and water.



To move the boat it is far more efficient to action the oars inside the water than in the air.

characteristic impedance of air is about 420 Pa s/m
characteristic impedance of water is about 1.5 MPa s/m
(nearly 3600 times higher)

the purpose of horns

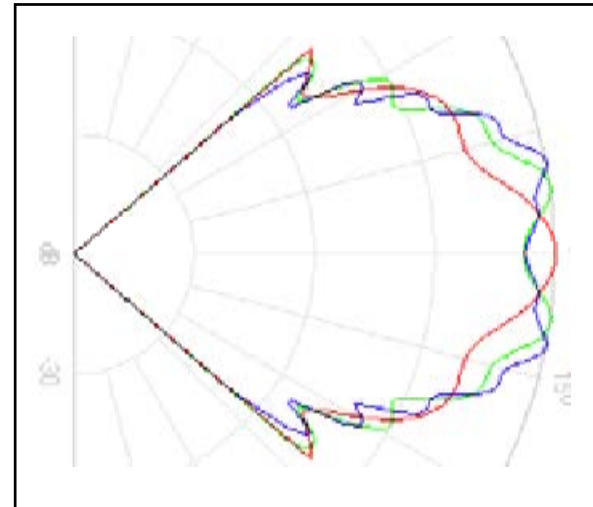
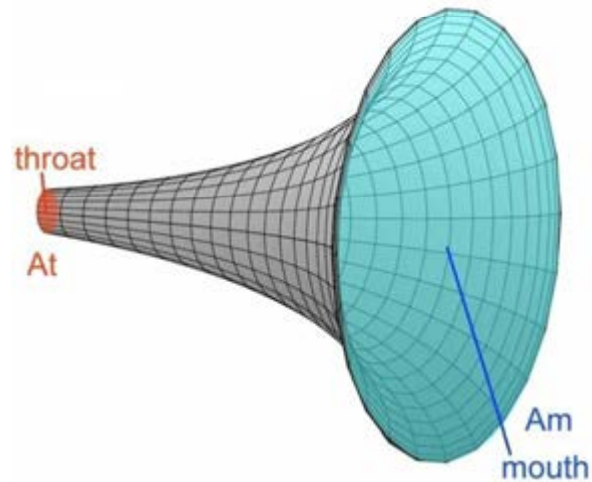

- to progressively adapt the acoustical impedance from the throat to the mouth
- to control the dispersion of the waves outgoing from the horn

The specific acoustic impedance z of an acoustic component (in $\text{N}\cdot\text{s}/\text{m}^3$) is the ratio of sound pressure p to particle velocity v at its connection point:

$$z = \frac{p}{v} = \frac{I}{v^2} = \frac{p^2}{I}$$

Where:

p is the sound pressure (N/m^2 or Pa),
 v is the particle velocity (m/s), and
 I is the sound intensity (W/m^2)

**Sound power:
if no loss inside the horn:**

$$P_m = P_t$$

**Sound intensity:
it is the sound power per
unit area**

$$I_t = P_t / A_t$$

$$I_m = P_m / A_m$$

Thus:

$$I_t / I_m = A_m / A_t$$

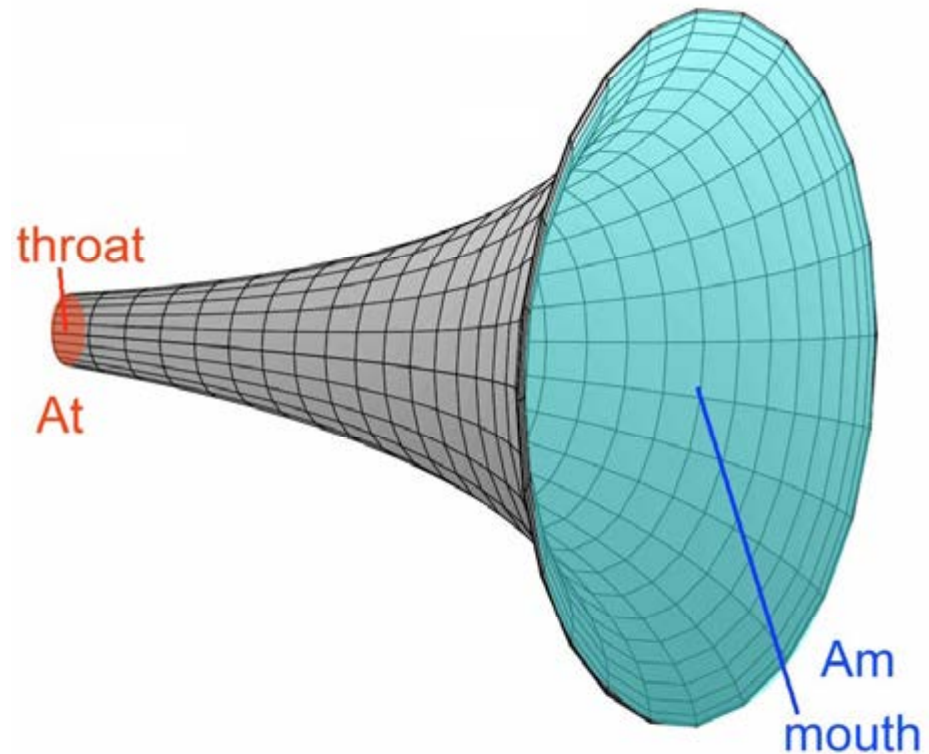

For a given sound intensity
the intensity at throat will be
proportionnal to the ratio of
the mouth area on the throat
area

acoustical impedance adaptation

the horn creates a higher acoustic impedance for the transducer to work into, thus allowing more power to be transferred to the air.

- increase of efficiency (up to 50%)

 - use of low power amplifiers

 - lower distortion due to smaller displacement of the membrane

- acoustical gain (10dB and more)

control of the dispersion of the sound waves

- depends on the need of a narrow or a wide spread of the sound in the room

Webster's equation

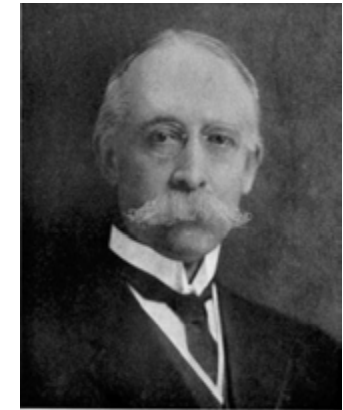

Arthur Gordon Webster

Webster's equation for a constant bulk modulus:

$$\frac{1}{c^2} \frac{\partial^2 p}{\partial t^2} = \frac{\partial^2 p}{\partial x^2} + \frac{1}{S} \frac{dS}{dx} \frac{\partial p}{\partial x}$$

where :

$$c^2 = B/\rho$$

The only assumption which has been made is that the wave is a function of one parameter

No further assumption is made about the shape of the isophase surfaces. Plane waves, spherical waves, or other wavefront shapes can be assumed within the framework of Webster's equation.

One parameter hypothesis or 1P hypothesis

- 1) pressure p depends only on a single coordinate
- 2) only longitudinal waves propagates from throat to mouth

Single Mode.
 Wave propagation inside cylindrical pipes can be described by a one-dimensional theory. Waves set up inside approximately cylindrical instruments have plane wavefronts of nearly identical pressure perpendicular to the wall. They propagate just like in open space but are partially reflected and partially transmitted by any change of cross-sectional area within the pipe. They are described by the one-dimensional (z-axis) wave equation

$$\frac{1}{z^2} \frac{\partial^2 p}{\partial z^2} = \frac{\partial^2 p}{\partial t^2} \quad (3.1)$$

The complex solution for the pressure $p(z, t)$ is

$$p(z, t) = (Ae^{-ikz} + Be^{ikz})e^{i\omega t} \quad (3.2)$$

with wave number k , wave length λ while $\lambda = \frac{2\pi}{k}$ and $\omega = 2\pi f$. A and B are the complex amplitudes of the forward resp. backward travelling pressure waves.

Theory tells us:

only 3 shapes for the wavefront and for the infinitesimal sound duct obey to the 1P hypothesis:

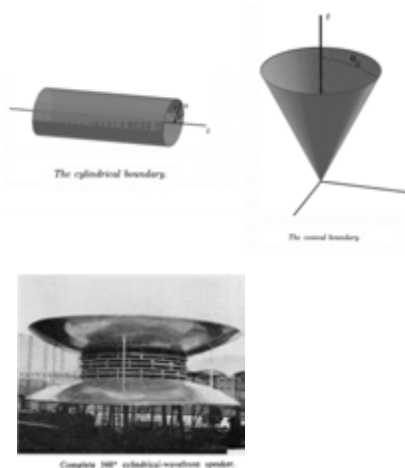

wavefront shape:
 planar
 spherical cap
 cylinder

duct shape:
 cylindrical tube
 conical horn
 toroidal horn

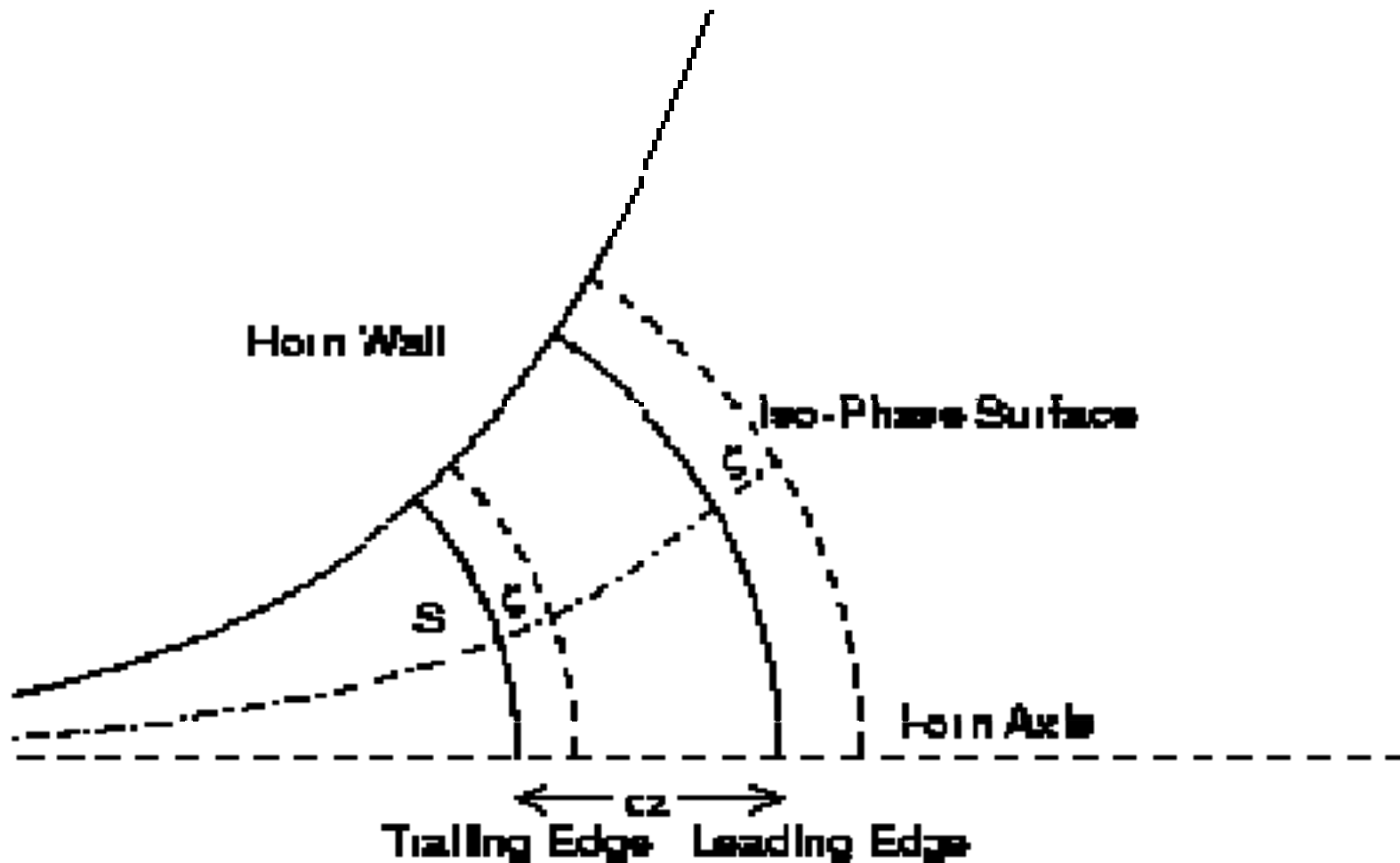

- isophase surfaces are parallel
- isophase surfaces are perpendicular to horn wall
- isobare (= isopressure) surfaces are parallel to isophase

William Hall (1932)

COMMENTS ON THE THEORY OF HORNS

By WILLIAM M. HALL
Massachusetts Institute of Technology

ABSTRACT

The present theory of horns makes a number of assumptions and approximations relative to the nature of the motion within the horns. This paper discusses these assumptions and presents the results of an experimental investigation of the sound fields within a conical and an exponential horn. These results show the conditions actually existing in these particular cases, and therefore indicate to a certain extent the validity of the above assumptions and approximations.

at the frequencies measured. Change in its location produced no noticeable effect on the output of another transmitter mounted near it, and the general consistency of the results obtained tend to substantiate the measurements.

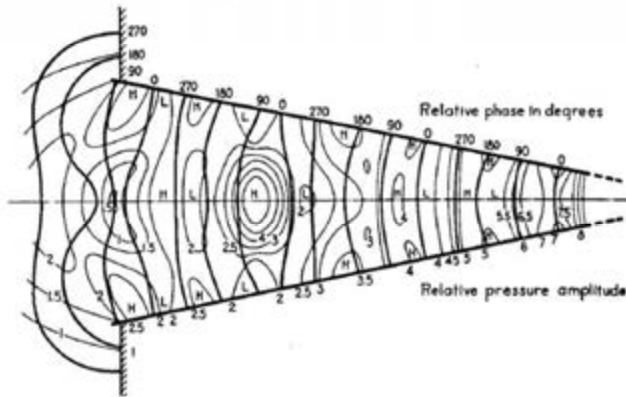

PLATE III. *Relative amplitude and phase of pressure within conical horn at 800 c.p.s.*
 Diameter of mouth of horn 76 cm.
 Length of horn 183 cm.

The investigation was limited to the case of infinitesimal waves. Therefore no information was obtained relative to the assumptions and approximations of the classical theory of sound as they have been outlined above. However, the investigation did give considerable informa-

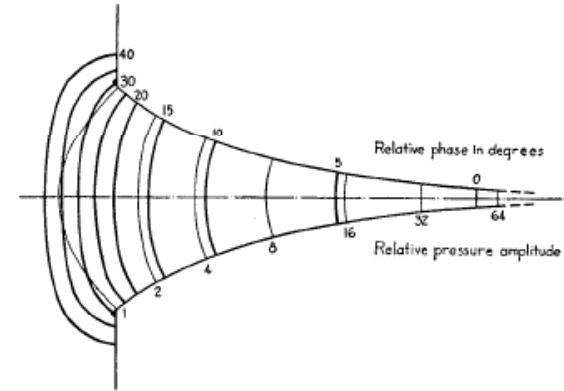

PLATE I. *Relative amplitude and phase of pressure within exponential horn at 120 c.p.s.*

Diameter of mouth of horn 72 cm.
 Length of horn 173 cm.
 Area given by $A = A_0 e^{-0.001x}$.

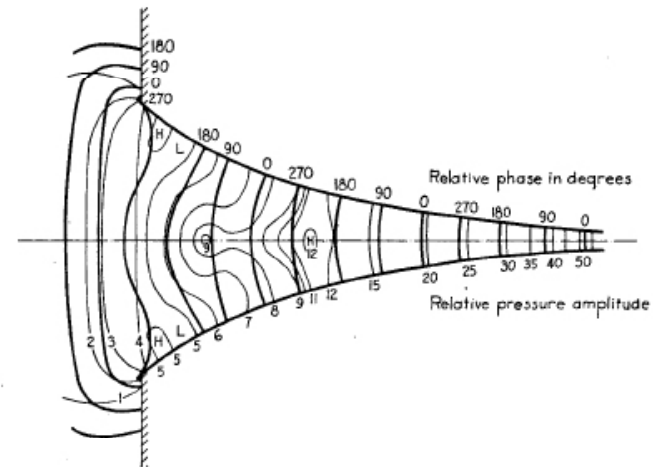

PLATE II. *Relative amplitude and phase of pressure within exponential horn at 800 c.p.s.*

For horns for which p depends on 2 or 3 coordinates we have to take in account high order modes (HOM).

The general solution to the Helmholtz equation in a 2D waveguide can be written

$$p(x, y) = (Ae^{-i\sqrt{\omega^2/c^2 - \zeta^2}x} + Be^{i\sqrt{\omega^2/c^2 - \zeta^2}x})(Ce^{-i\zeta y} + De^{i\zeta y}),$$

where $\zeta = n\pi c/(2a)$, $n = 0, 1, 2, \dots$. The cut-off frequency f_c of a higher order mode is associated with the longitudinal wavenumber becoming imaginary. This occurs at $\omega_c = n\pi c/(2a)$ or $f_c = nc/(4a)$. With $a = 0.05$ m and $c = 345$ m/s, we have $f_c = 1725$ Hz for $n = 1$. At 850 Hz, the amplitude of the first non-planar mode will decay with a factor of around 10^6 within a distance of $\ell = 0.5$ m. Thus, setting the upper frequency bound to 850 Hz, the higher mode contamination at Γ_{in} can thus be expected to be negligible.

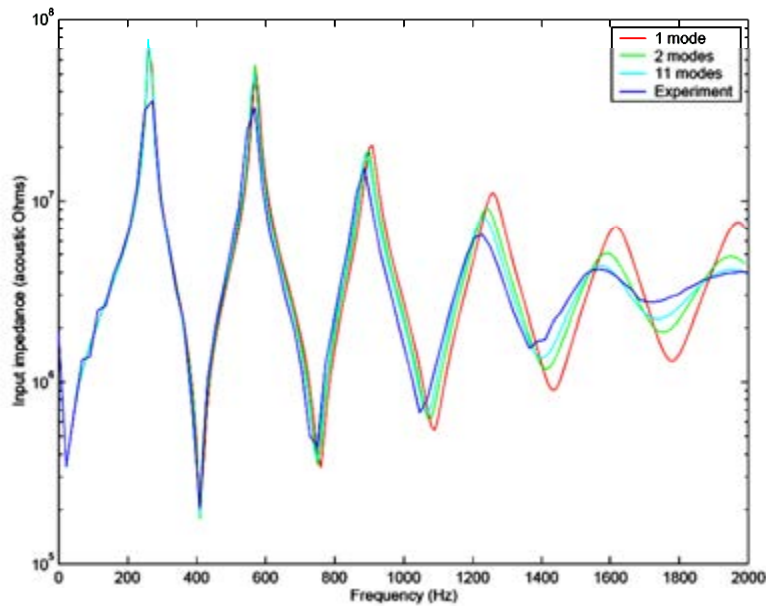

Trumpet section input impedance as calculated by Kemp

to take in account the
 fundamental mode only is
 not sufficient to rely
 simulation to measurement

Isobare curves inside a horn

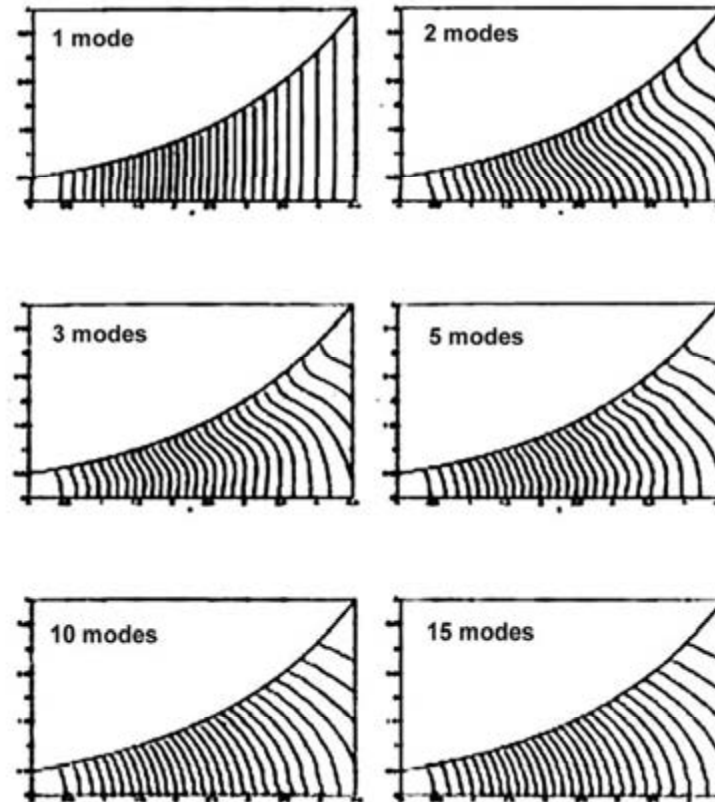

The quest for efficiency, the quest for loading



The Construction and Performance of a 25ft. Logarithmic Horn.

R.P.G. Denman, "In Search of Quality", Wireless World, Vol. 25 pp97-101 (July 31, 1929)



Mr. Kei Ikeda's listening room

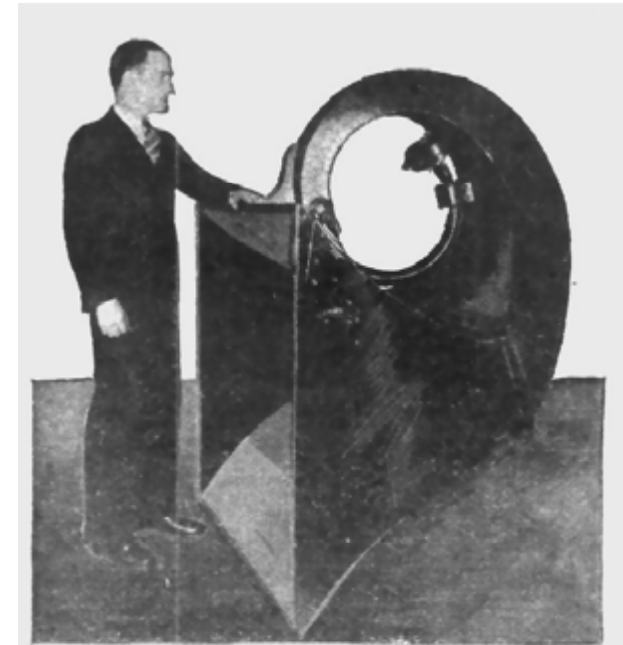

Horns as tall as a man are placed behind the silver screen. This is one of the giants which the audience never sees, but which is vital in making the movies talk.

Julien Sullerot's WE15A replica on top of an Onken W enclosure



In 1926, the Vitaphone system uses the famous driver WE 555-W coupled to the WE15A horn (100Hz to 5kHz)

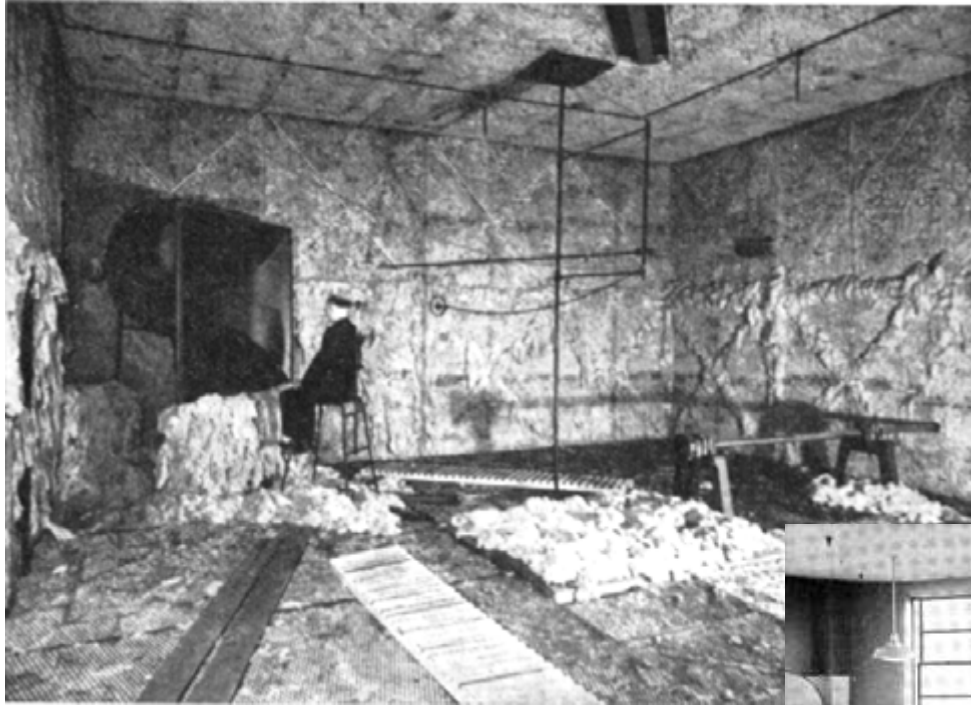

Acoustic studies using the WE15A .

See on right Wente's planar waves tube he used to measure the power response of the WE555 driver

development of the *Stereophonic* system (commercially introduced in 1933)





Hollywood goes for sound

© David Fisher

Majors' film releases in 1928

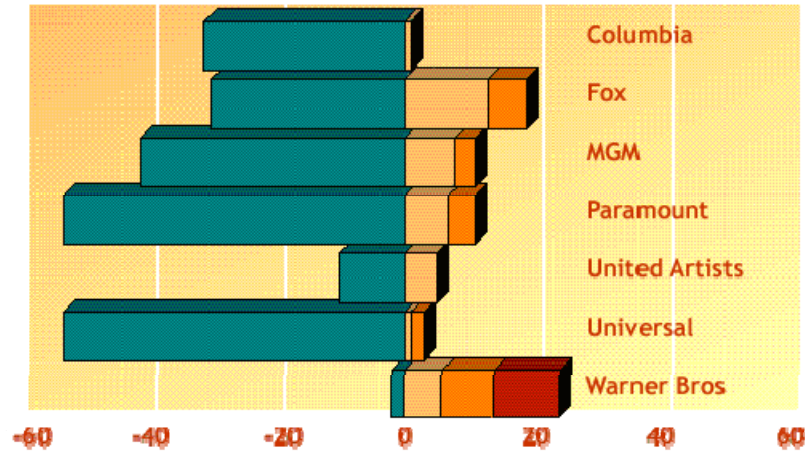

In 1928 the seven Hollywood majors released 220 silent films and 74 sound films, of which 41 had only synchronized music and sound effects, 23 were part talkie and only 10, all from Warner Bros, were all talkie. Universal and Paramount in particular were still heavily committed to silent productions.

silent films
 synchronized music and sound effects

1926 "Don Juan" first talking movie,

Majors' film releases in 1929

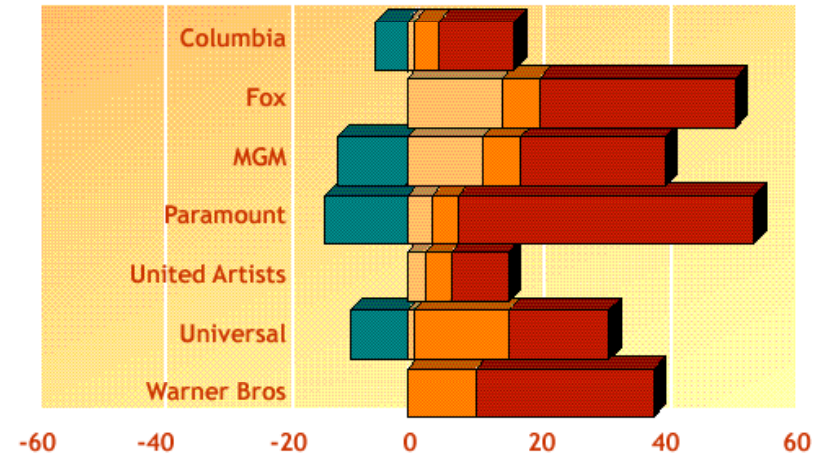

In 1929 the balance had shifted radically. By now there were 166 all talkie releases, 50 part talkie and 36 with only music and effects. Silent releases had dwindled to only 38 out of a total of 290.

part talkie
 all talkie

1927 "The Jazz Singer"



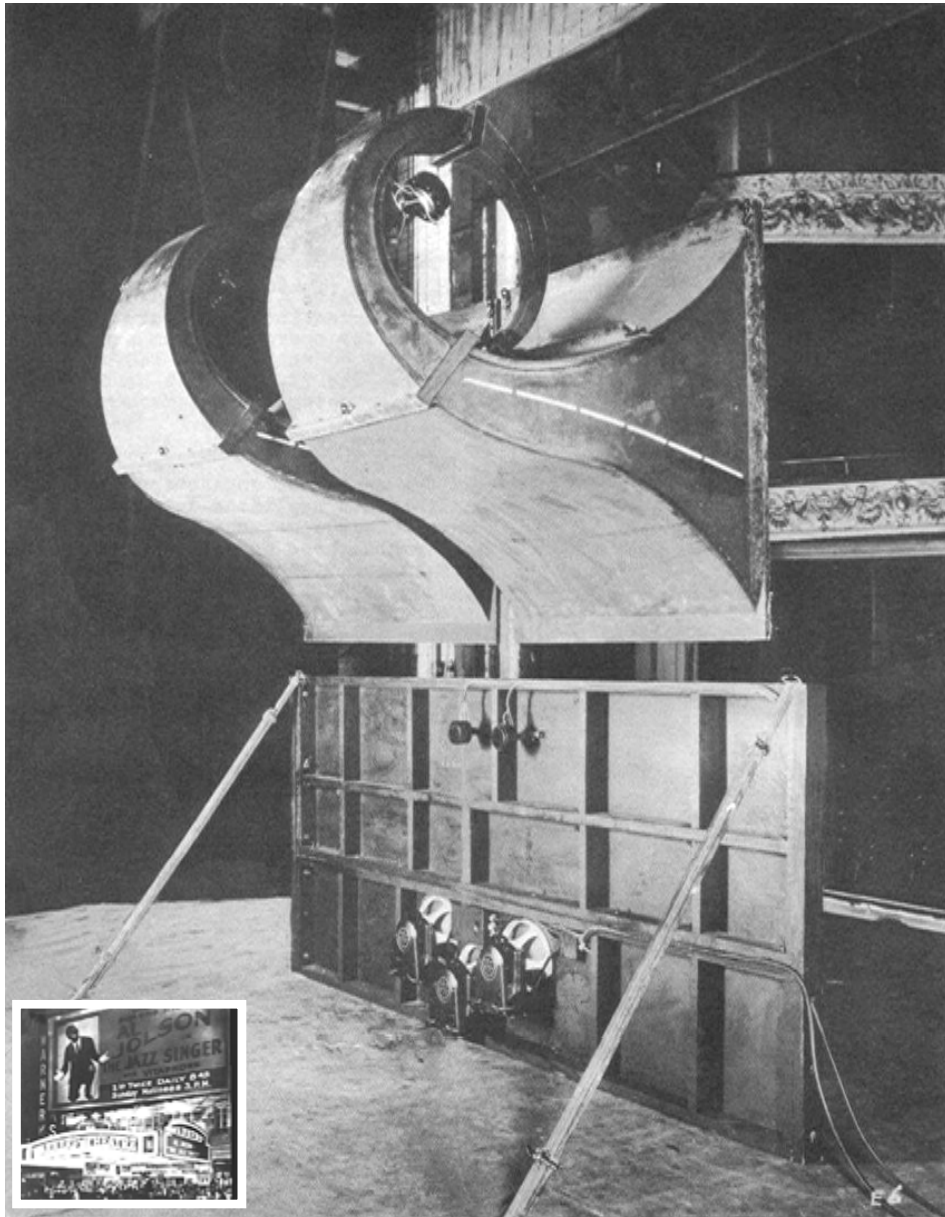

Talking Devices are Revolutionizing Movies!

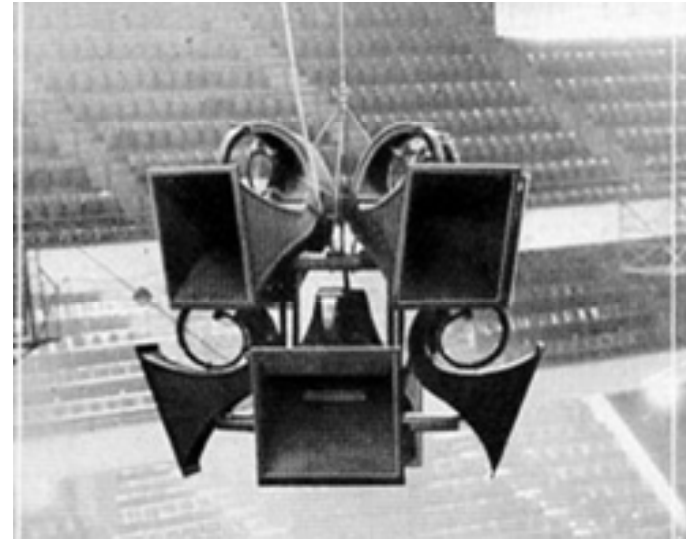

Talkies Created New Movie Jobs, But Put Many Musicians Out of Work

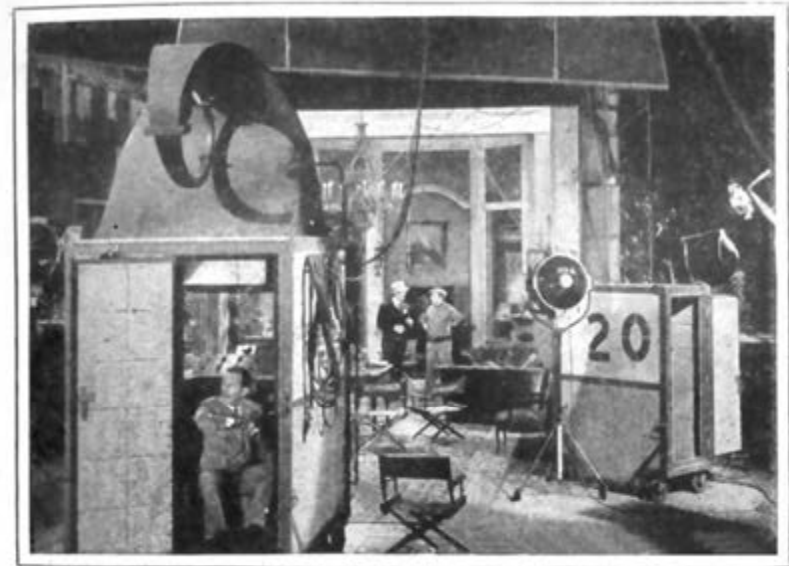

This maze of electrical equipment is used in making sound pictures which have put thousands of musicians out of work, replacing theater orchestras.

Talking Devices are Revolutionizing Movies!

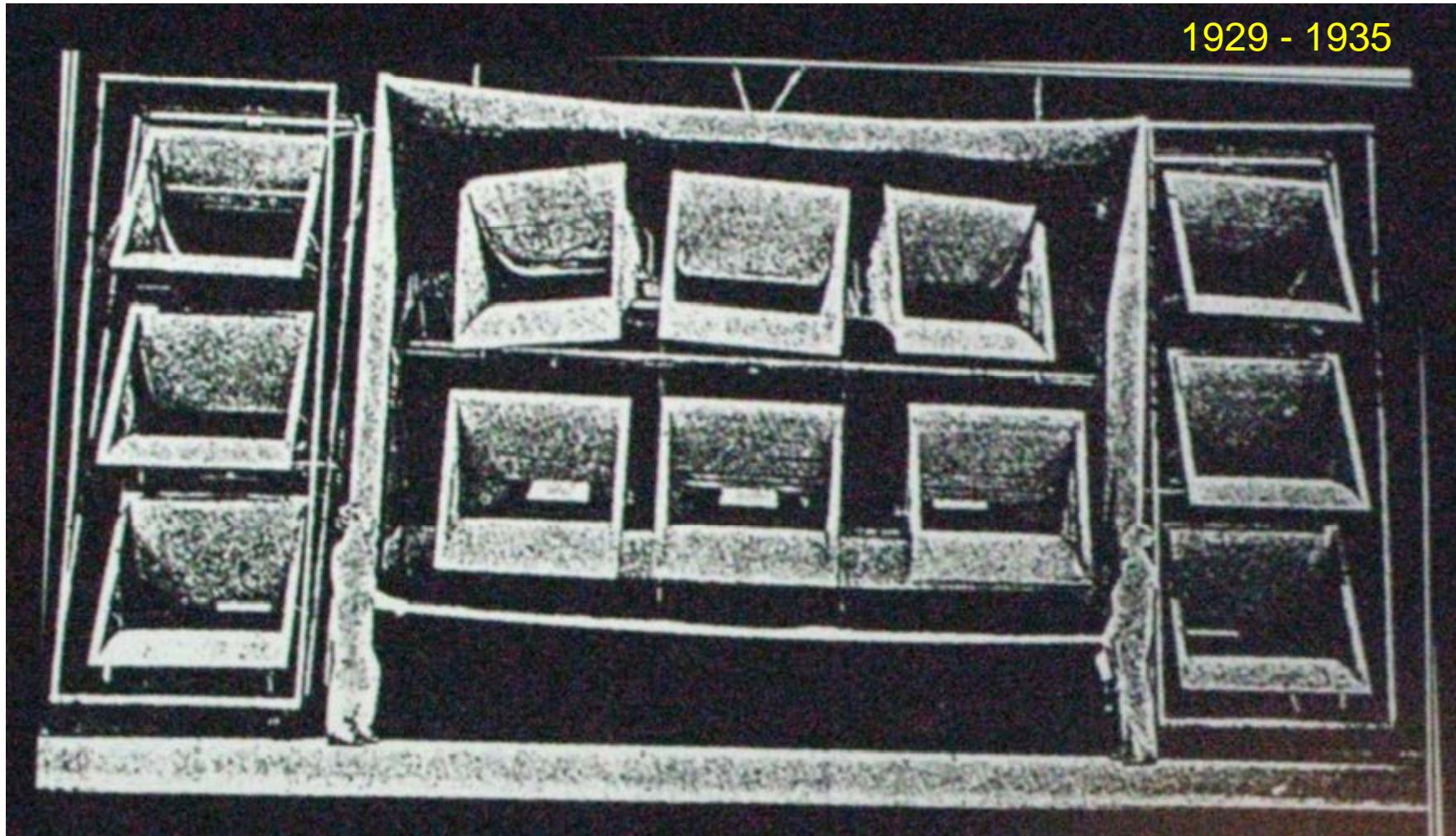

Sid Grauman's Chinese theater in Hollywood inaugurated in 1927

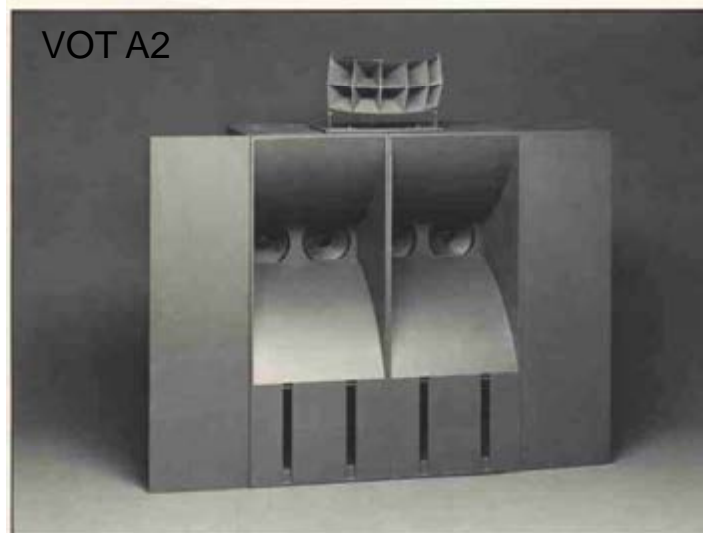
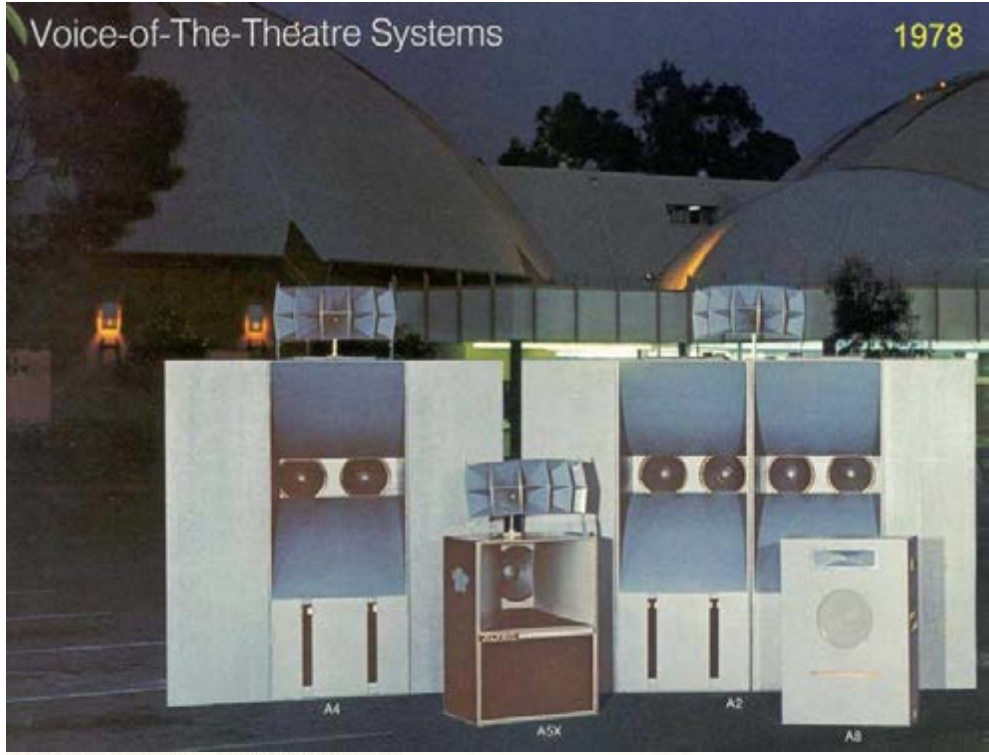

1960s

80x JBL375
+
40x JBL150H



600
acoustic
watts
Generator
for
vibration
analysis

© Harman International, Courtesy Mark Gander and John Eargle



re 16-77 Whelen Engineering horizontal diffraction horn with multiple drivers. (Courtesy Whelen Engineering Co., Inc.)

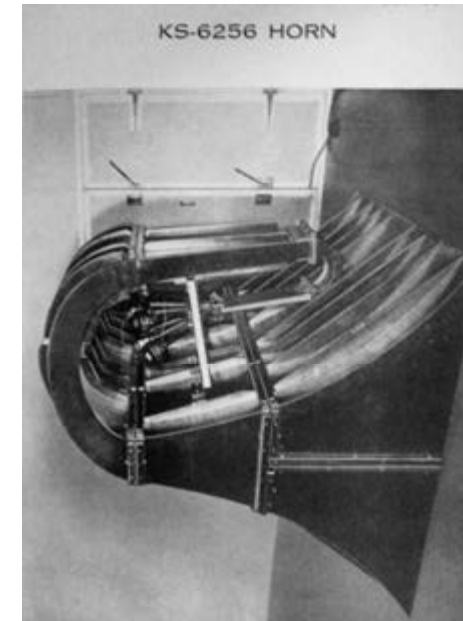

multiple horns

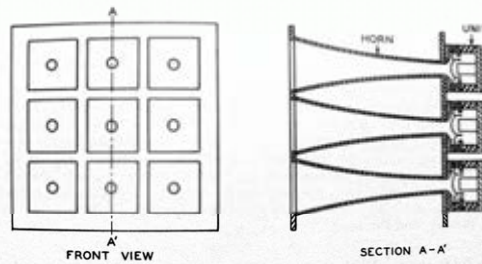

FIG. 7.24. A multiple-horn, single-channel system for high-power announce systems.

Related to horns

- acoustic lenses
- diffractor couplers (Karlson coupler)
- reflectors

Ein neues Bauelement: die „akustische Linse“

Durch Anbringen einer akustischen Zerstreuungslinse vor einem Lautsprecher läßt sich dessen Schallaustrittswinkel vergrößern, eine Maßnahme, die bei Hochtonlautsprechern oft erwünscht ist — vor allem in breiten Theatern — weil dadurch die Seitenplätze besser mit hohen Frequenzen versorgt werden.

Die akustische Linse ist in ihrer Wirkung einer optischen Linse vergleichbar. Es hat sich nämlich gezeigt, daß die für Lichtwellen geltenden Gesetze sich in analoger Weise auch für Schallwellen anwenden lassen, man kann also auch hierfür Sammel- oder Zerstreuungslinsen herstellen.

Abb. 3 zeigt die Brechungsverhältnisse an einer plan-konkaven optischen Zerstreuungslinse. Beim Eintritt der ankommenden Lichtwellen in das optisch dichtere Mittel (Glas) wird ihre Fortpflanzungsgeschwindigkeit herabgesetzt, wodurch eine Brechung stattfindet (die einfallenden Lichtstrahlen werden zum Lot hin gebrochen). Beim Austritt aus dem optisch dichteren Mittel vergrößert sich die Fortpflanzungsgeschwindigkeit wieder und es ergibt sich eine nochmalige Brechung (die ausfallenden Lichtstrahlen werden vom Lot weg gebrochen). Das einfallende Strahlenbündel wird durch die Zerstreuungslinse auseinandergezogen und tritt mit vergrößertem Raumwinkel wieder aus.

Die gleichen Verhältnisse, wie in Abb. 3 für Lichtwellen dargestellt, gelten auch für Schallwellen, wenn man diese durch eine entsprechend ausgestaltete Linse laufen läßt, in der ihre Ausbreitung durch Hindernisse verzögert wird. Hierfür können z. B. mehrere hintereinander befestigte Lochplatten oder starr aufgehängte, gleichmäßig im Linsenraum verteilte kleine Kugeln oder Scheiben verwendet werden. Die einzelnen Hindernisse und ihre Zwischenräume müssen kleiner sein als die kleinste zu übertragende Wellenlänge, die z. B. für 15 000 Hz 22 mm beträgt. Eine andere Möglichkeit besteht darin, linsenförmig zugeschnittene, jalouseartig schräggestellte Blechstreifen vor der Schallquelle anzubringen. Die Schallwellen werden dadurch zu Umwegen gezwungen, die am Rande der Linse größer sind als in der Mitte. Dadurch ergeben sich ebenfalls Brechungen, und die Schallwellen treten in Form von Kugelwellen mit vergrößertem Streuwinkel aus der Linse aus. Die Brechungsanzahl dieser Linse ergibt sich aus der Neigung der Blechstreifen zur Lautsprecherachse.

Eine derartig akustische Linse, die sich als Zusatzeinrichtung auch nachträglich an einem Hochton-Kugelwellenrichter anbringen läßt, zeigen Abb. 4 und 5. Sie ist als Zylinderlinse ausgebildet, ihre konkave Seite ist dem Lautsprecher zugewandt. Der Streuwinkel wird also nur in der horizontalen Ebene vergrößert, auf die es in breiten Filmtheatern ankommt, in der Vertikalebene dagegen nicht.

Wichtiger als bei Hochtonlautsprechern mit Kugelwellenrichtern, die bereits einen verhältnismäßig breiten Streuwinkel haben, ist jedoch die Verbreiterung des seitlichen Streuwinkels bei Konuslautsprechern, da diese die hohen Frequenzen stärker bündeln. Eine neue Klangfilm-Lautsprecherkombination „Duophon“, bei der für die

Hochtonwiedergabe Konuslautsprecher mit akustischer Linse verwendet werden, ist im nachstehenden Lautsprecherprogramm mit aufgeführt.



Abb. 3. Brechung paralleler Lichtstrahlen beim Durchtritt durch eine Zerstreuungslinse. In ähnlicher Weise verbreitert sich eine Schallwellenfront beim Durchtritt durch eine akustische Linse



Abb. 4. Akustische Linse, Vorderseite

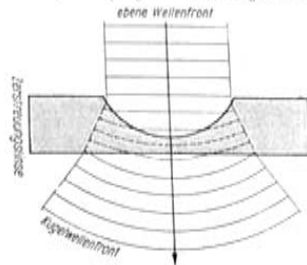

Abb. 5. Akustische Linse, Rückseite

JBL "potatoe crusher"

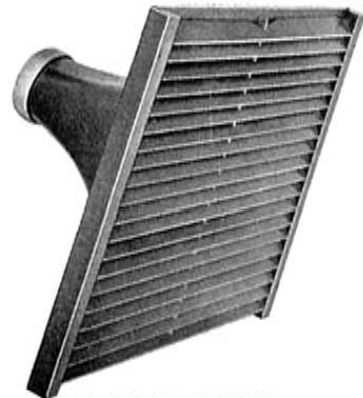

© Harman International, Courtesy Mark Candler and John Fargis

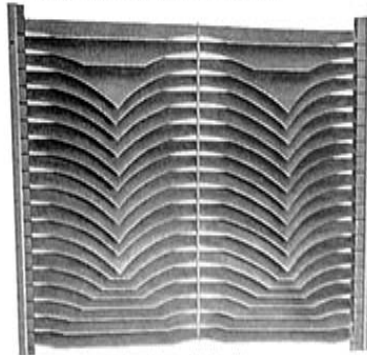
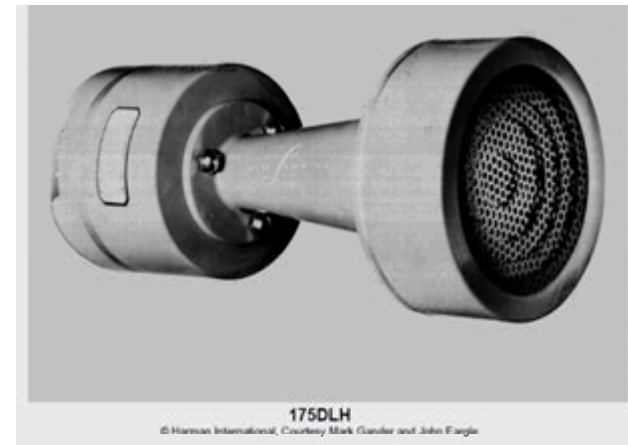
Acoustic lenses

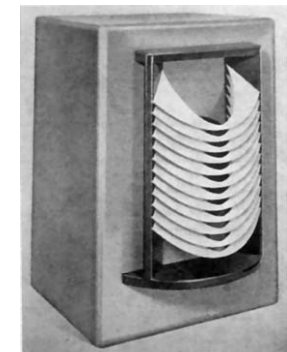
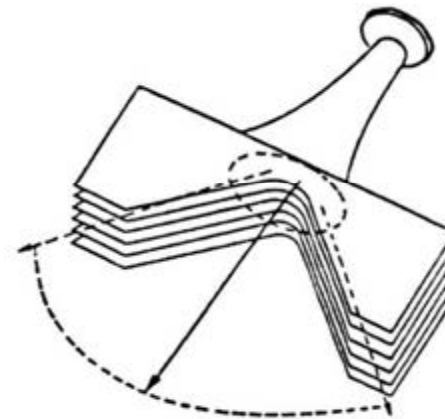

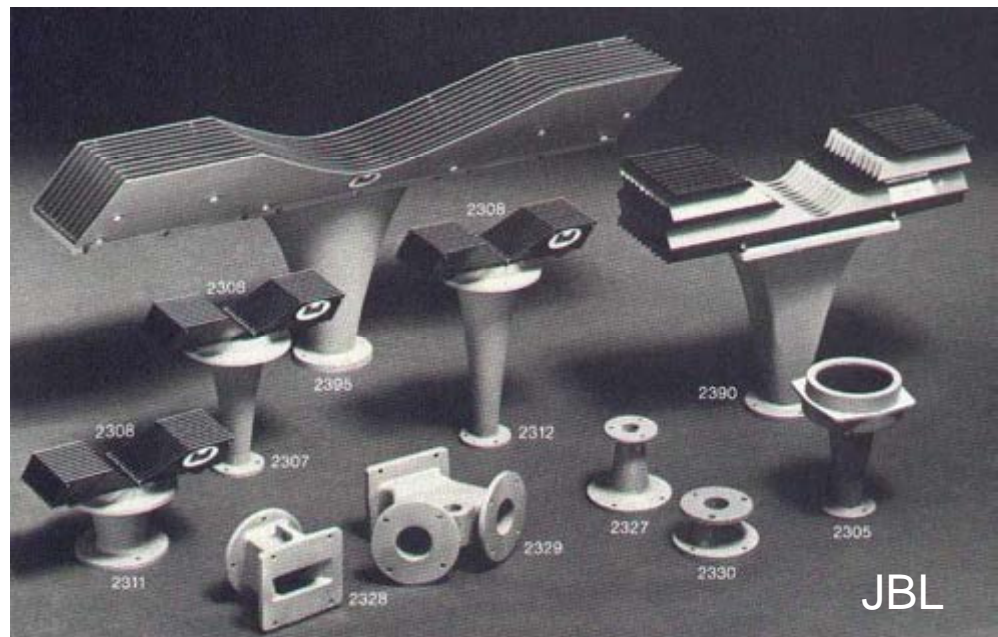
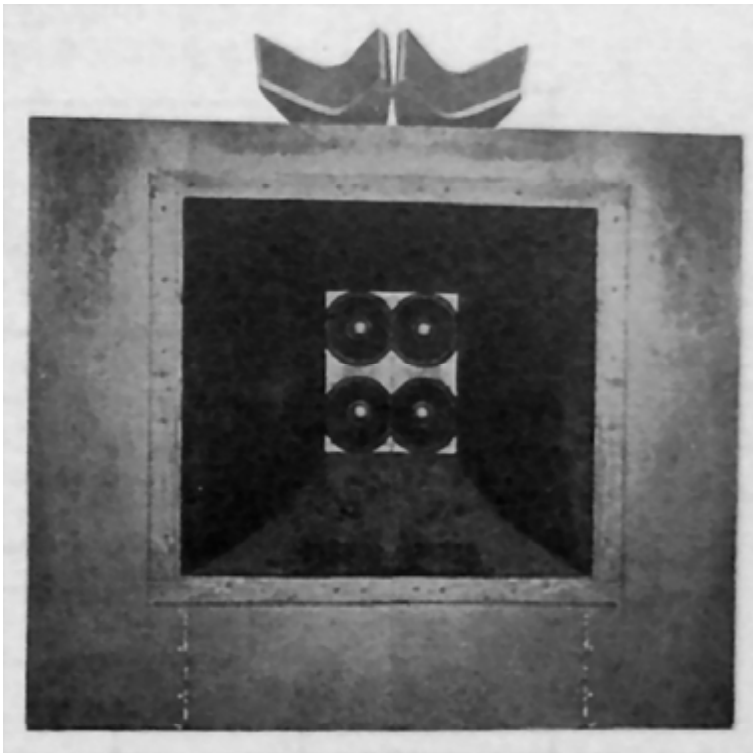

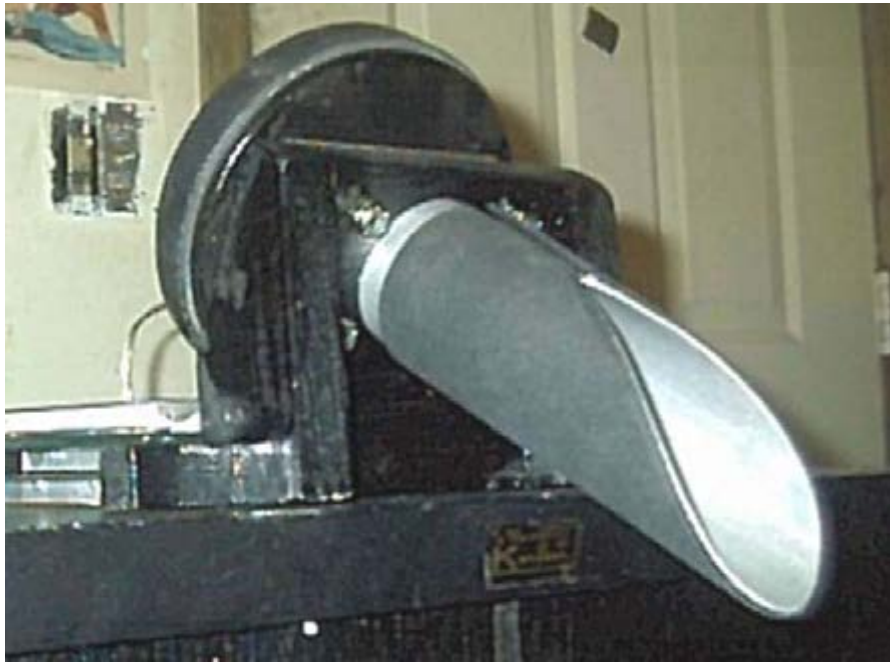

THE TUBE..

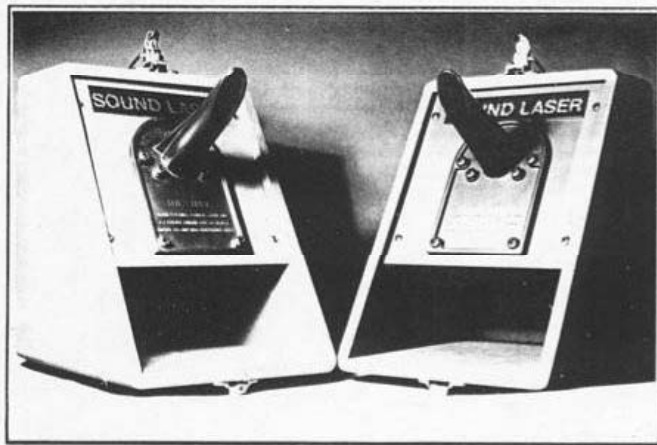

Product

The Tube is a direct replacement for all H.F. units that operate between 800 Hz and 25000 Hz (Depending on the Driver used).

order of a dB per degree occurs thereafter). The pattern does not vary with frequency unlike horns of even the multicellular and sectoral types.

Karlson coupler

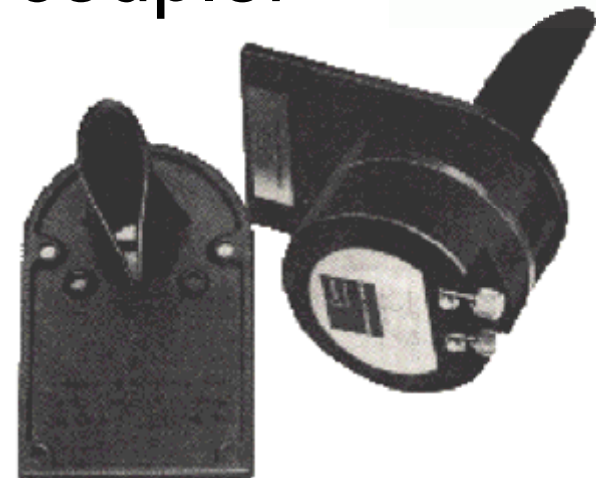

Elliptical reflectors = acoustic shells

1673

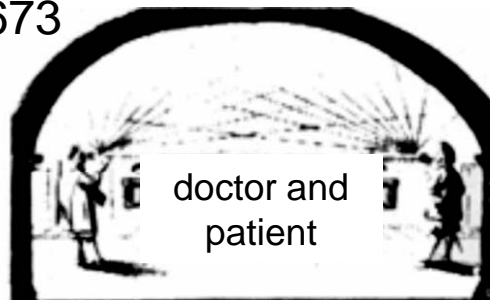

doctor and patient



locators

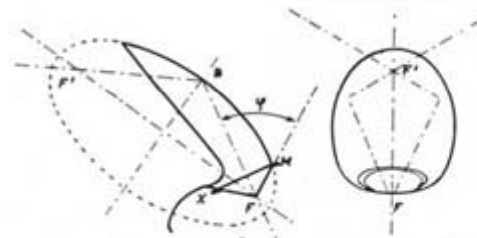
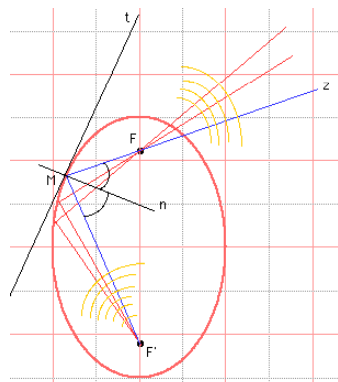
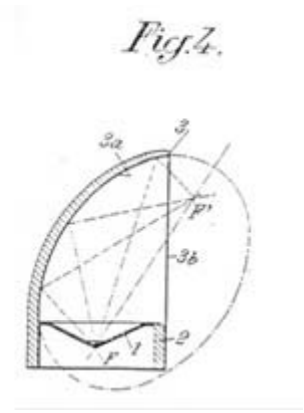
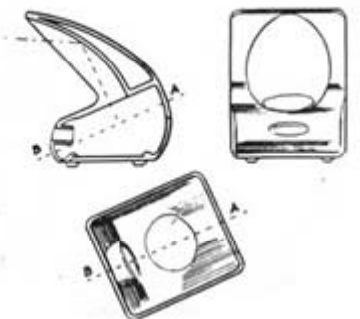
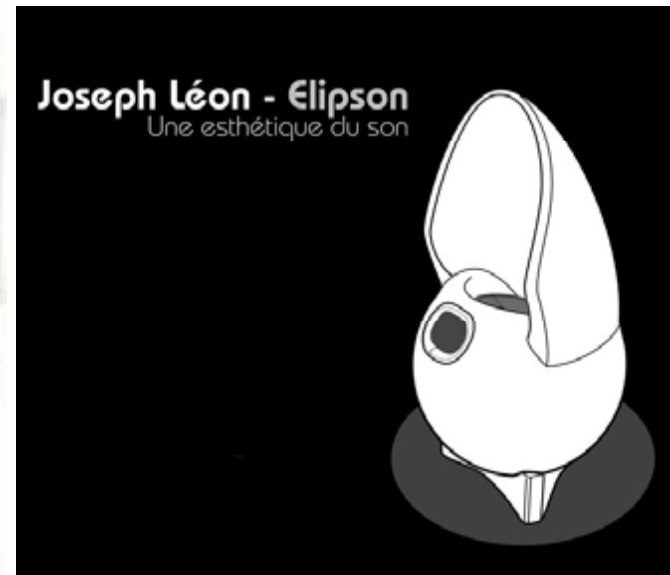
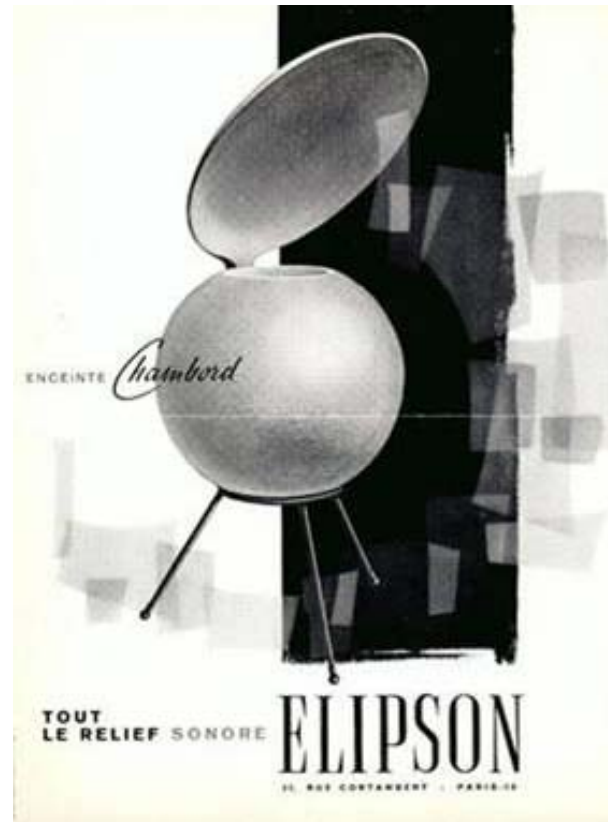

Fig. 2. — Coupe schématique d'une coque.



Elipson loudspeakers



Folding horns

- In search of miniaturization

old folded horns

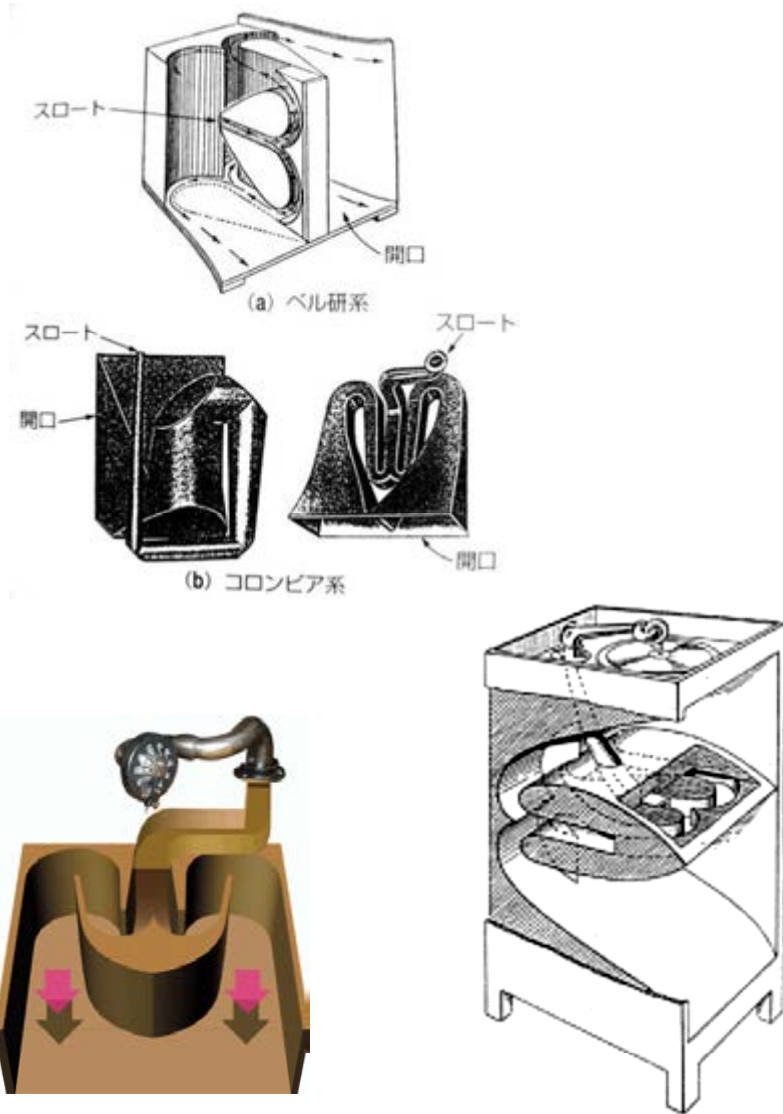



WE 13A horn

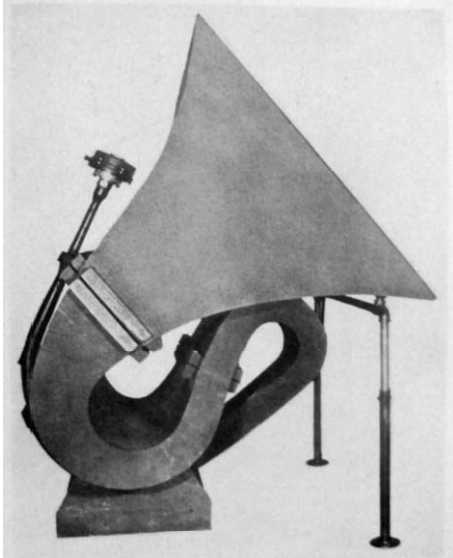

1929 - 1935

Radio Increases Milk Yield of Cows With Musical Ear

THAT cows will give more milk to the strains of music was proven when Ben Scott, in charge of the cattle at the Fredmar Farms near Oakville, Mo., installed a radio loudspeaker for the benefit of the restless bovines. They immediately showed signs of musical appreciation and stood still while they were milked. Some even cocked a musical ear while the soothing strains of a classical waltz came from the radio.

As an almost conclusive proof to the new idea, the cow pictured boasts of an official record for 3-year-olds with 840.98 pounds butter and 17,864 of milk.



Bossy yields record milk crop listening to boy-friend on radio. She does best under influence of the waltz, it was found.

WE « the Tub », circa 1938

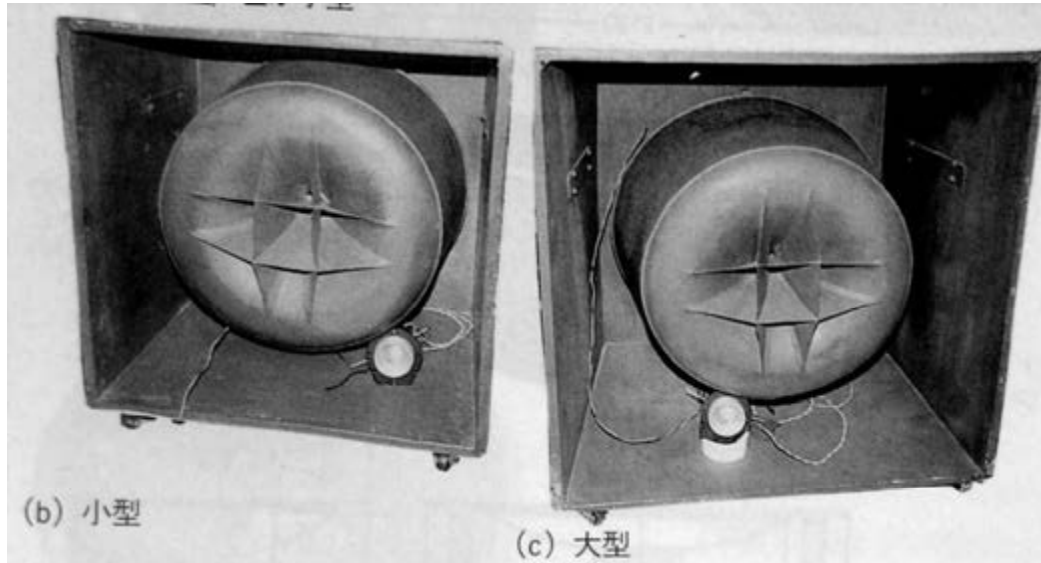

〔写真9〕 大型と小型の「The Tub」同軸型ホーン型2ウェイスピーカー

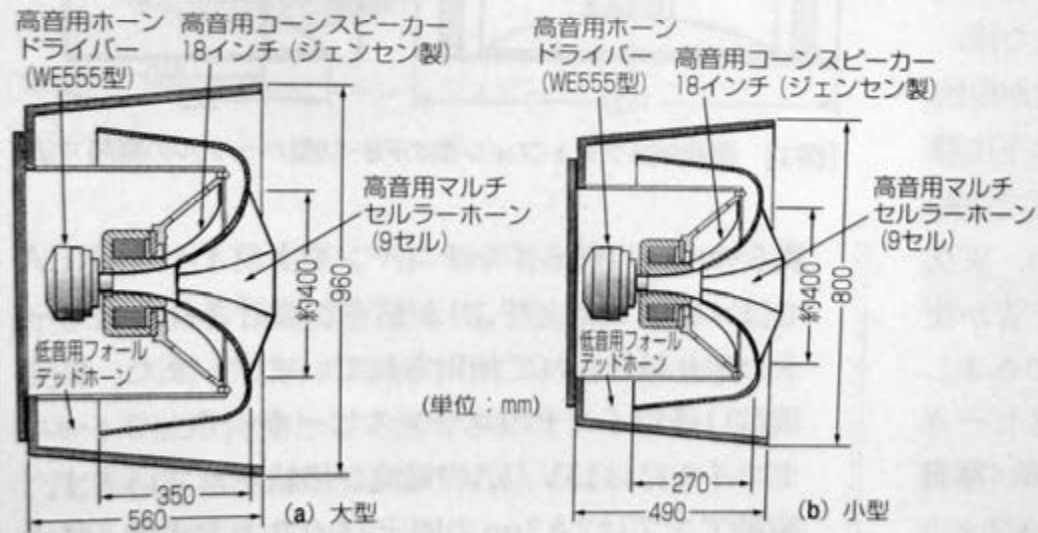

〔図4〕 「The Tub」の概略構造寸法



WE collector in Japan

Aug. 21, 1934.

E. C. WENTE
SOUND RADIATOR

1,970,926

Filed April 11, 1933 2 Sheets-Sheet 1

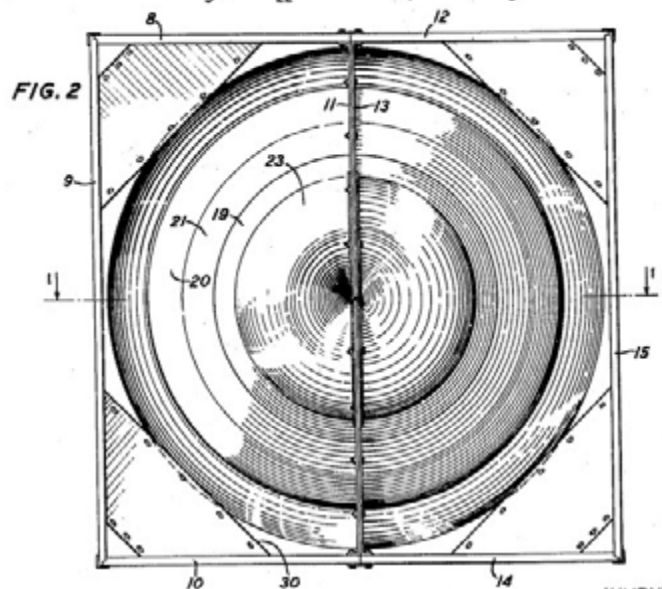
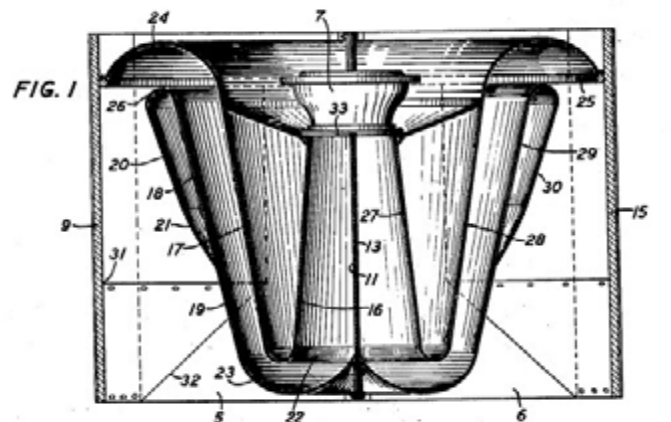

INVENTOR
E. C. WENTE
BY
Edgar W. Adam
ATTORNEY

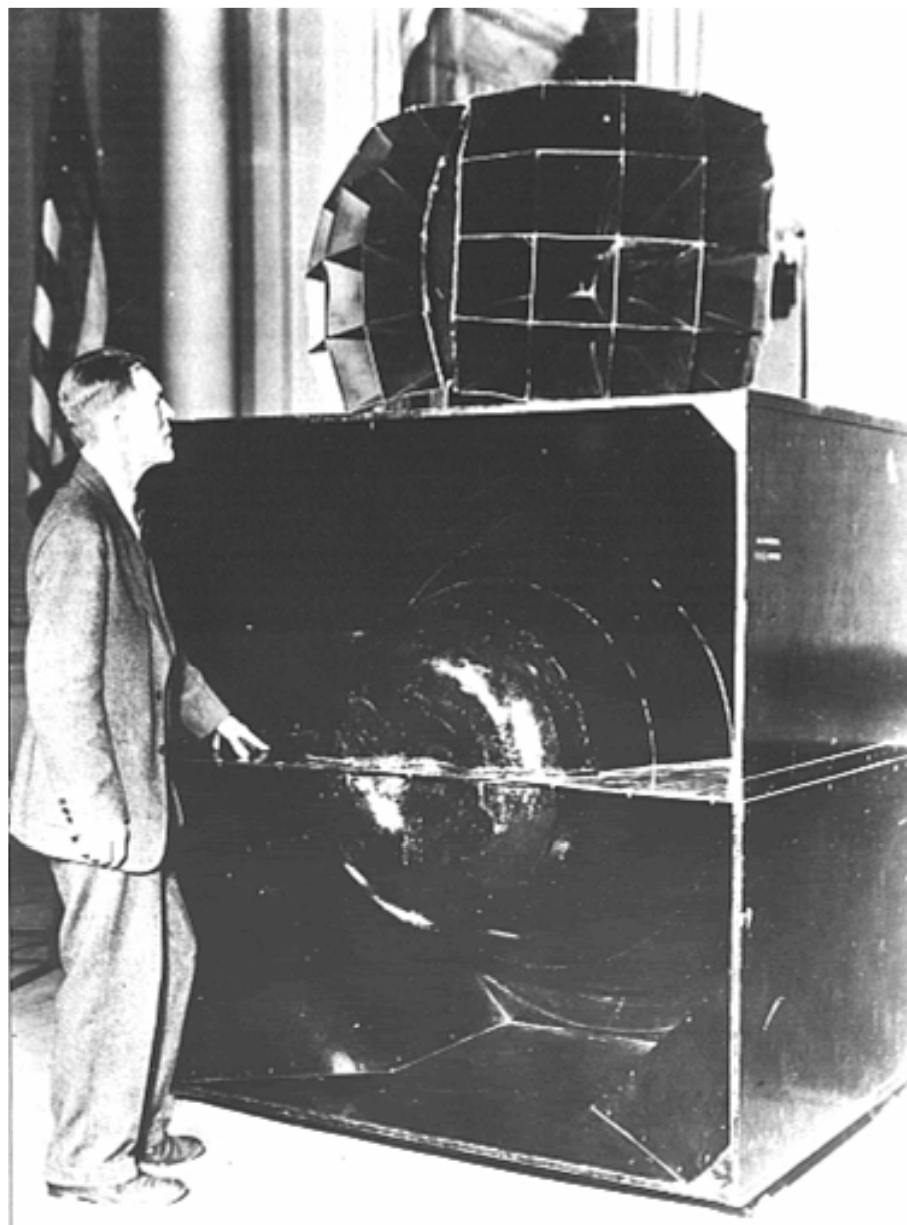

Fletcher system (1933-1940)

modern folded horns

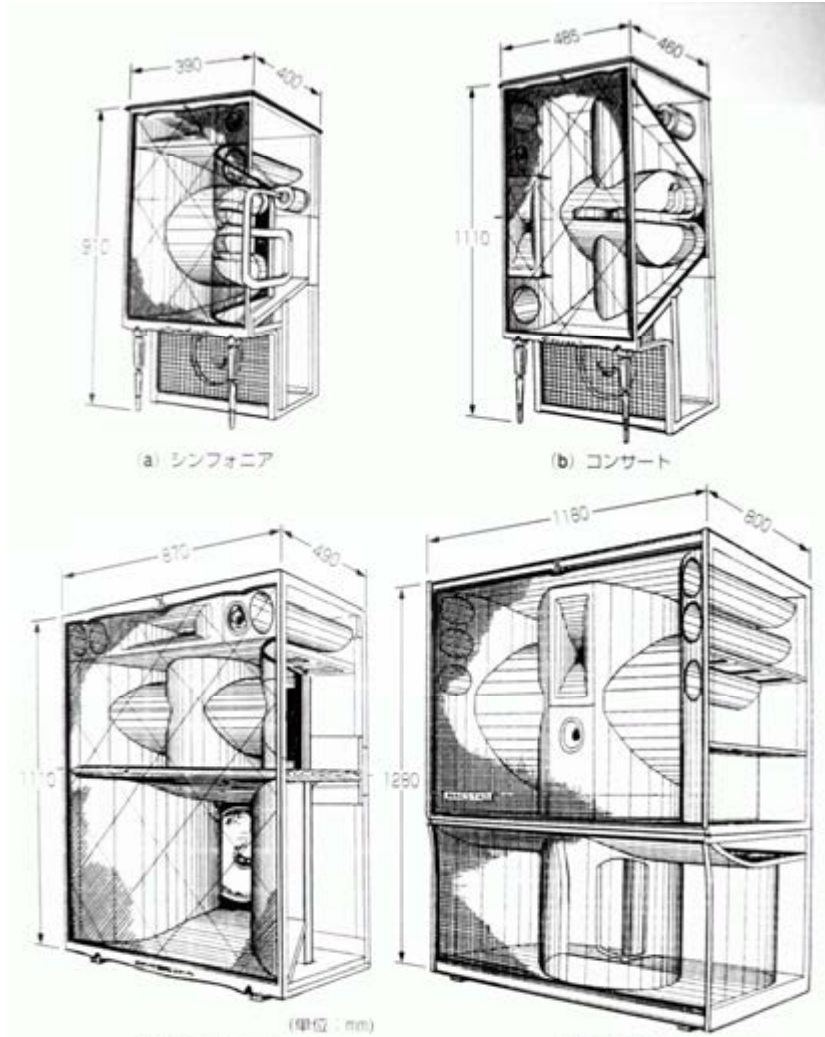

YL folded horns (Japan)

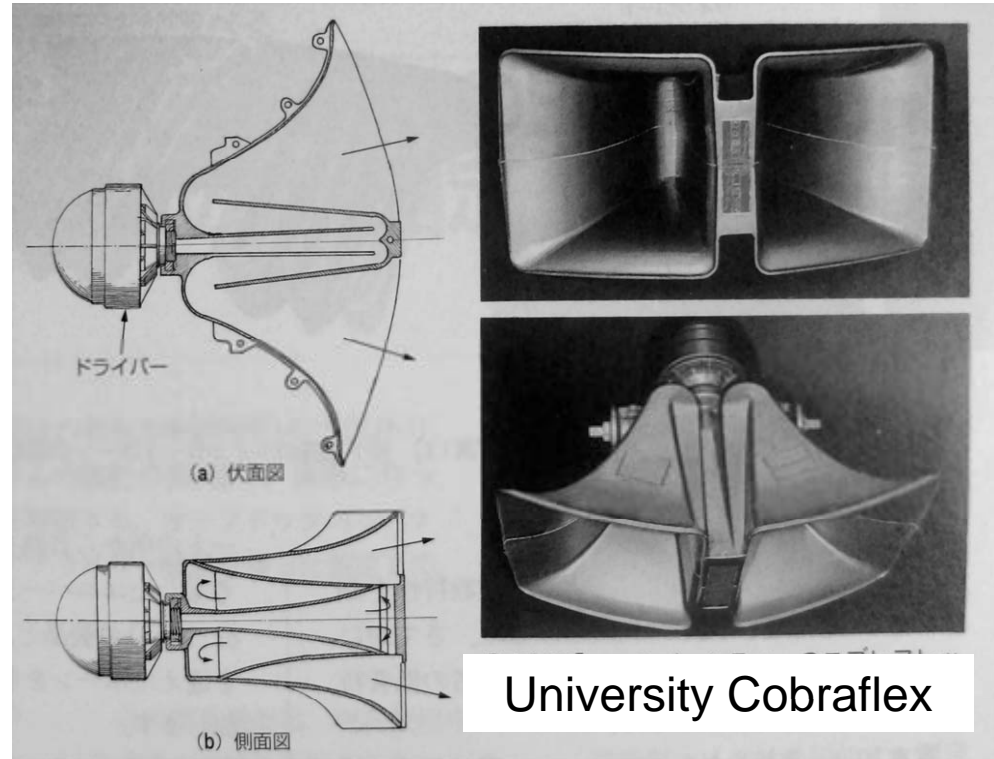



		
<p>中音用 / MB-150</p> <p>MB-150は、MB-90(II)の音質をそのままに小型化したオールアルミニウム合金製のホーンです。フレヤー部分はデドニング加工により、ホーン鳴りを防止し、開口面も小型で自作キャビネットに手軽に組みこむことができます。</p>	<p>中音用 / MB-90(II)</p> <p>独自の木製ホーンで、低音限界は55系ドライバート組むと200Hzに、D-75,000ドライバートでは150Hzと、2通りに使えます。スペースを取らない折曲型ホーンで、コンスピーカーでは得られない明確なハリのある豊かな再生音が楽しめます。</p>	<p>中低音用 / MB-70</p> <p>中低音D-75,000専用につられたL型ホーンです。フレヤー部分は精密加工の積層</p>

Yoshimura Laboratory, Ale and Goto horns



Nelson Pass's fullrange Kleinhorn



Yamamura fullrange
Churchill and Dionisio 32

First folded bass horns

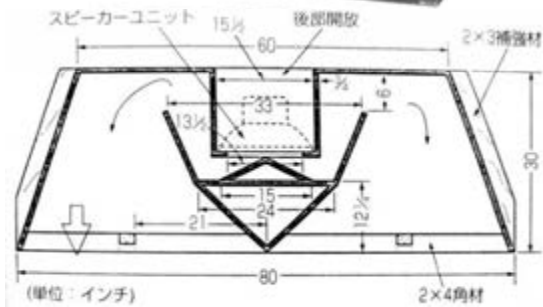

WE TA7396, 1936 -1937

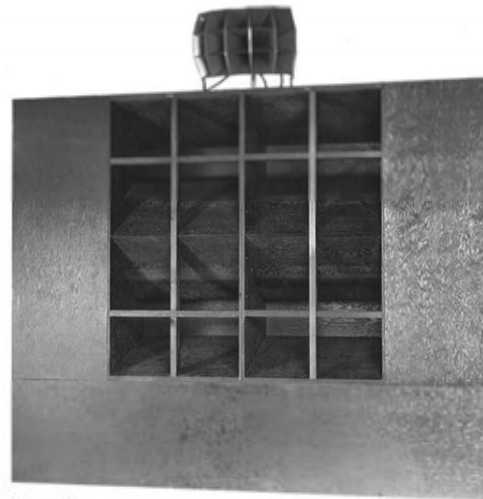

Front

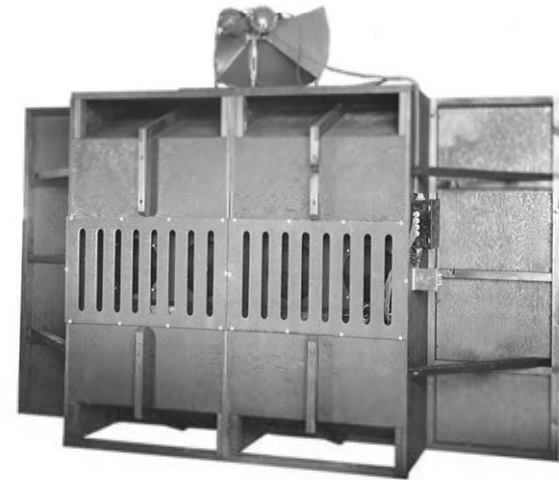

Back

the Shearer horn

Lansing Manufacturing 75W5 Shearer Horn
© Harman International. Courtesy Mark Gander and John Eargle

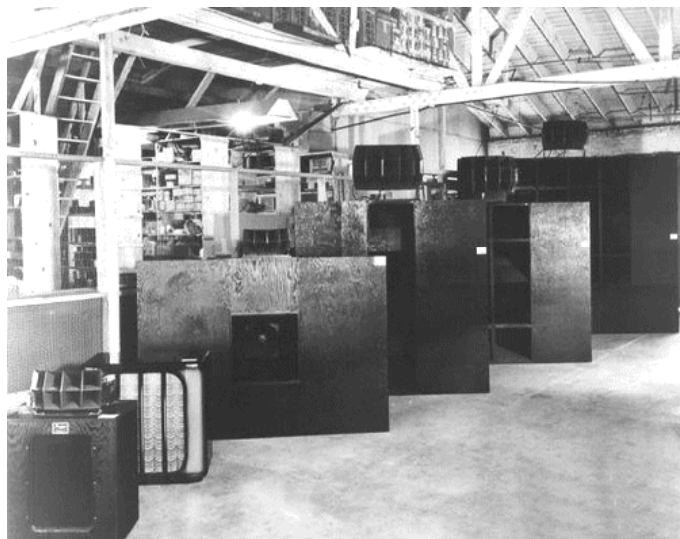

The Shearer system received a technical achievement award at the 1936 Academy of Motion Picture Arts and Sciences ceremony.

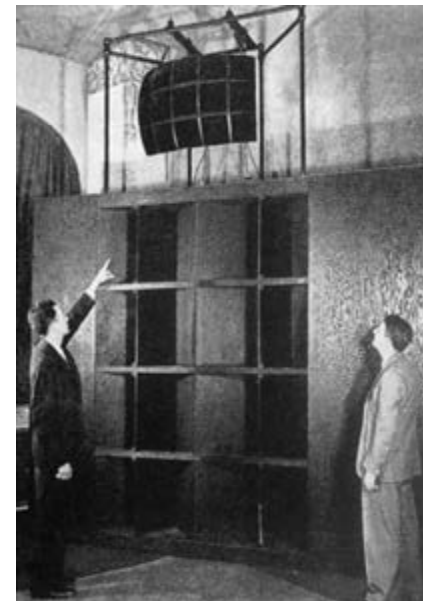

RCA

Straight horns

Early exponential straight horns

Before 1929



my home made crystal radio with a Vitavox E190 horn

TA 7322 HORN

REQUIRES - ONE 555 RECEIVER

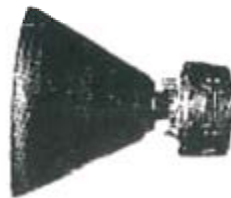

Western Electric (WE)

3A

This straight horn in a small metal fabrication, it seems to be built in the early 1920s. The main use of it is in combination with balanced armature-type receiver, as 196w, 549 or 551, for a public address use.



Western Electric (WE)

TA7322

The wooden horn "TA7322" of this circular type was developed in 1935 for the midrange channel above 600Hz, of the "TA8002" wide range system with WE555 and 2 woofer units type TA4151 for the low frequency. Size of the horn is diameter 32cm and depth 23cm. This is probably the smallest genuine horn for the 555 receiver (Doi)

Horn tweeters

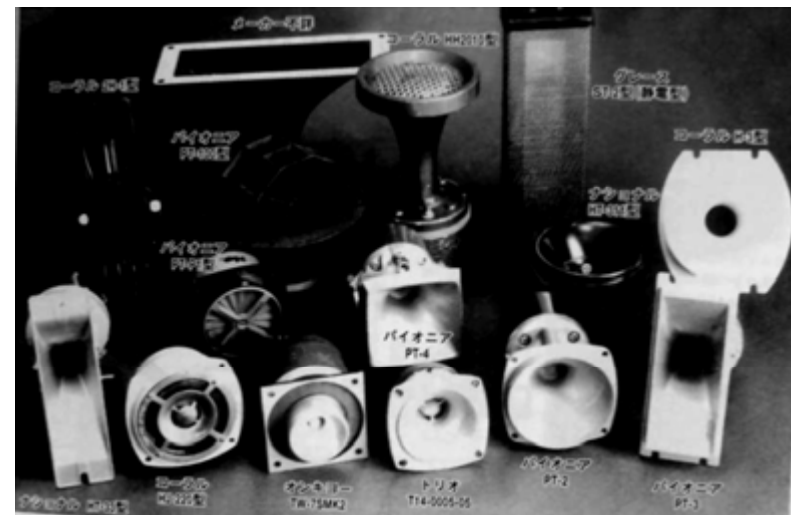
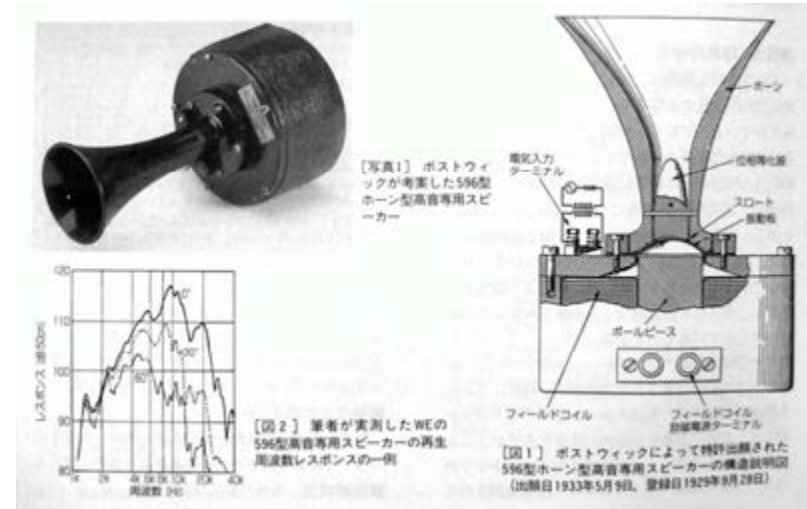
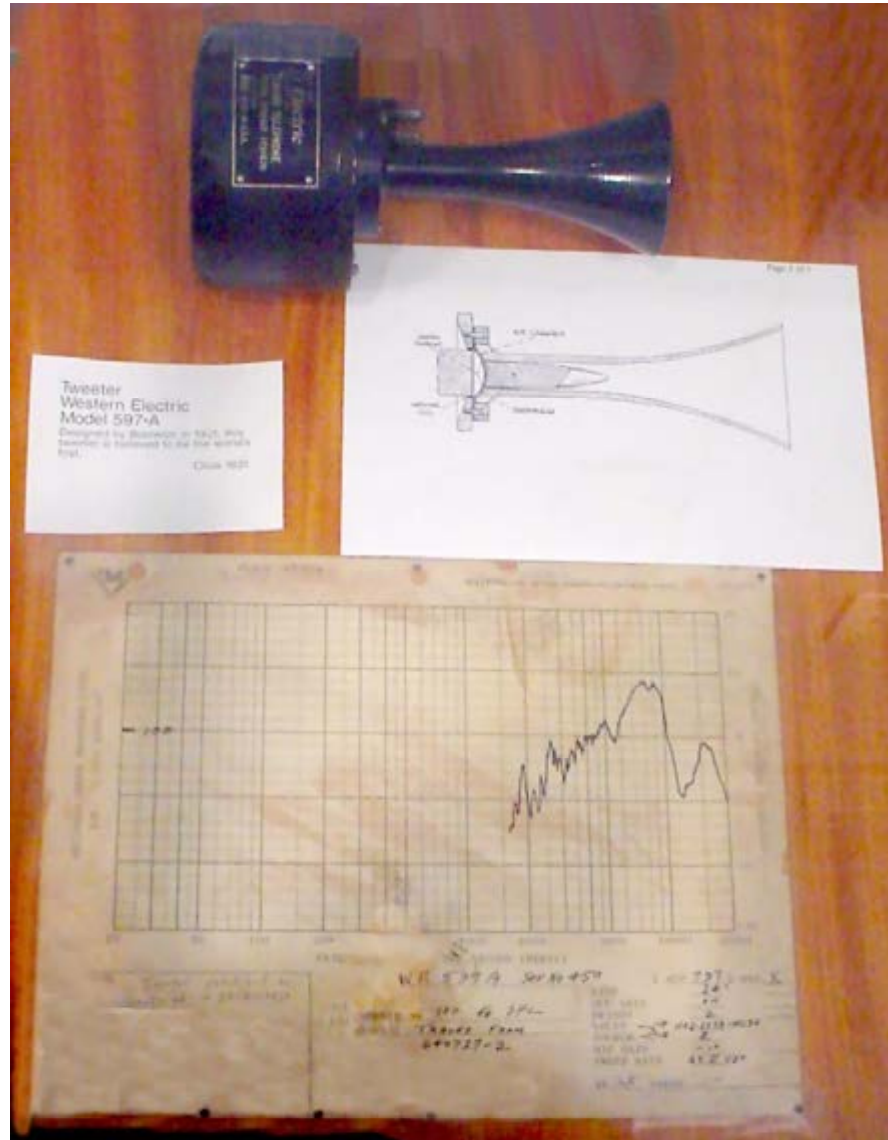

Klangfilm
20 Hz Tractrix horn
Germany, 1951

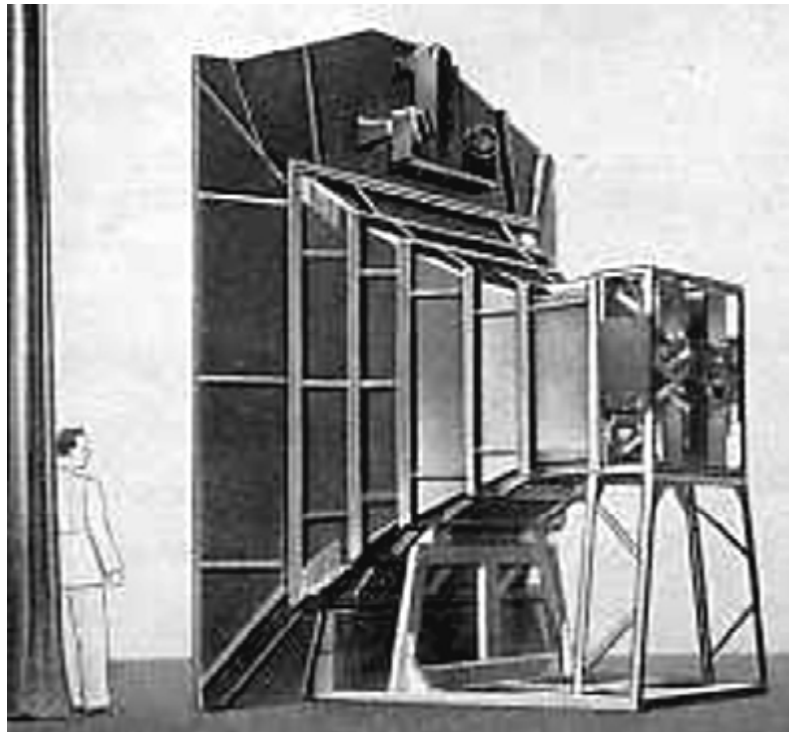

Straight bass horns



Bjorn Kolbrek's long throw bass horns





Vincent Brient's 30Hz bass horns (France)



Klaus Speth, full horns with Goto drivers (Germany)

Quasi cylindrical waves bass horns in France

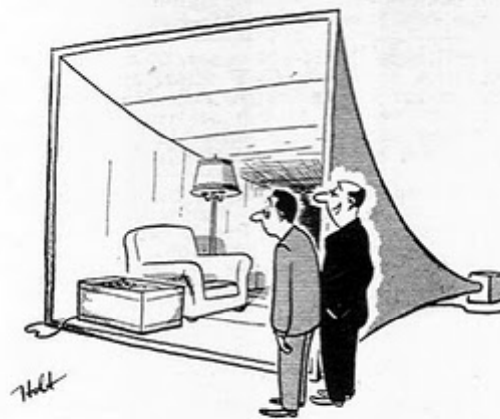

... and this is my listening room

AUDIO • APRIL, 1954



main families of horns

- Salmon family (exponential, hypex, etc.)
- Tractrix, Kugelwellen and Spherical
- conical
- oblate spheroidal
- Le Cléac'h

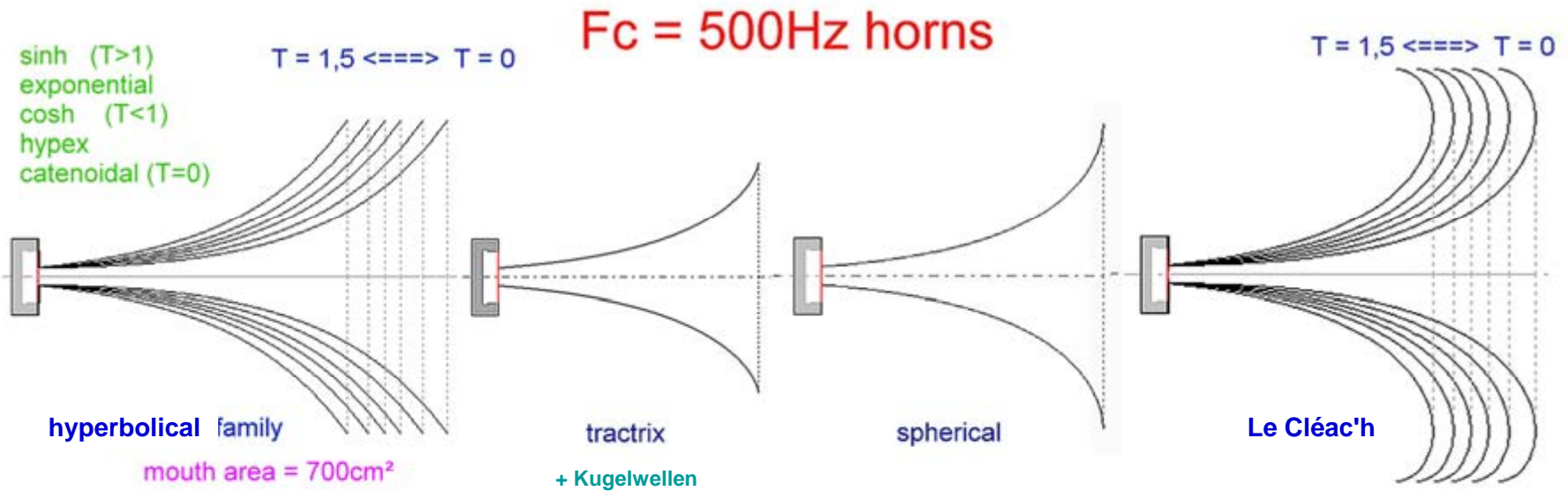

conical and waveguides

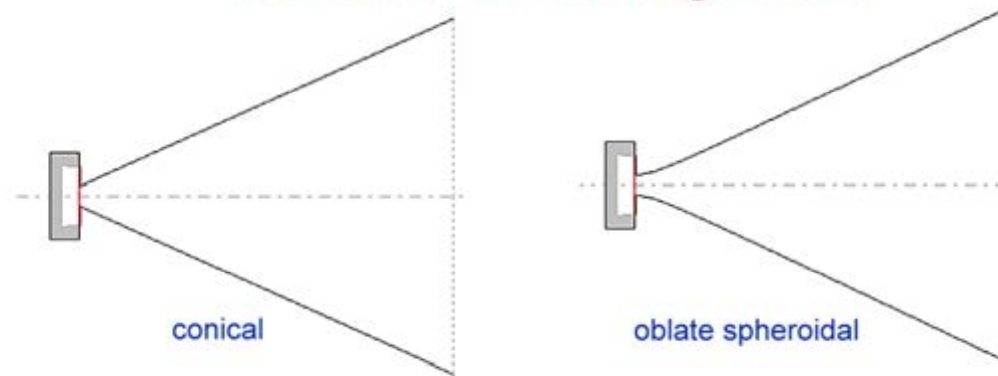

same mouth area and length as the exponential horn

hyperbolical type

- from catenoidal ($T = 0$)
- through hypex ($0,5 < T < 1$)
- and exponential ($T = 1$)
- to hyperbolic sine ($T > 1$)

$$Z_1 = \frac{R \cos(\beta L + \theta) + j(X \cos(\beta L + \theta) + \sin \beta L)}{-X \sin \beta L + \cos(\beta L - \theta) + jR \sin \beta L}$$

$$= R^1 + jX^1$$

Formula for the acoustic impedance of an exponential horn

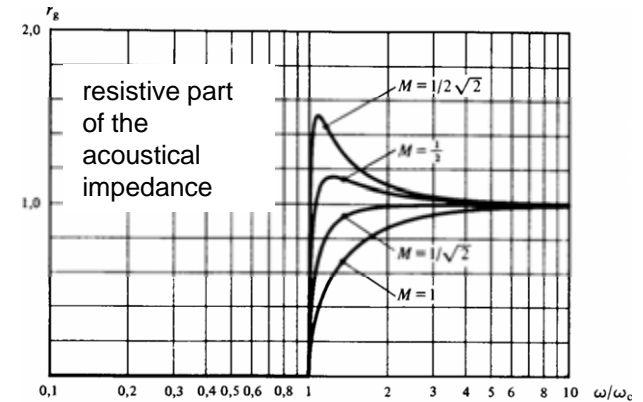

Fig. 4.13

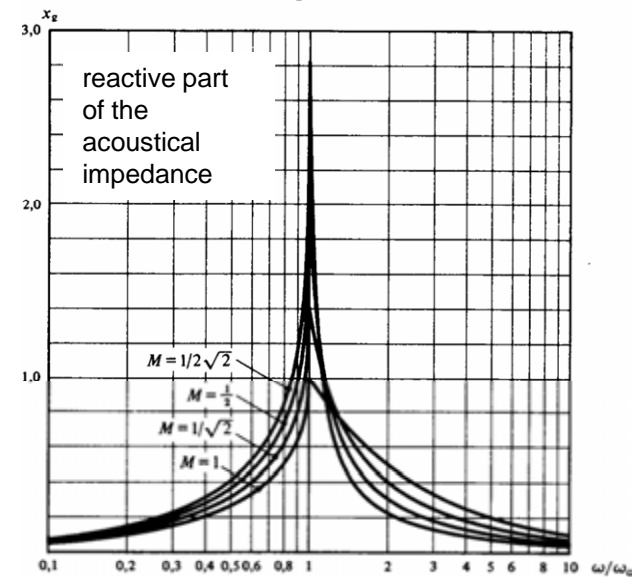

Fig. 4.14

hyperbolic / exponential horns

$$\text{Area} = \text{Throat Area} [\cosh (x*2*\text{Pi}*f / c) + M * \sinh (x*2*\text{Pi}*f / c)] ^2$$

where

- x = distance from throat
- f = the cutoff frequency of the horn
- M = the flare constant - $M = 1$ is exponential, $0 < M < 1$ is hyperbolic
- c = the speed of sound, approximately 13538 inches per second or 344 m/s (depends on temperature, etc.)

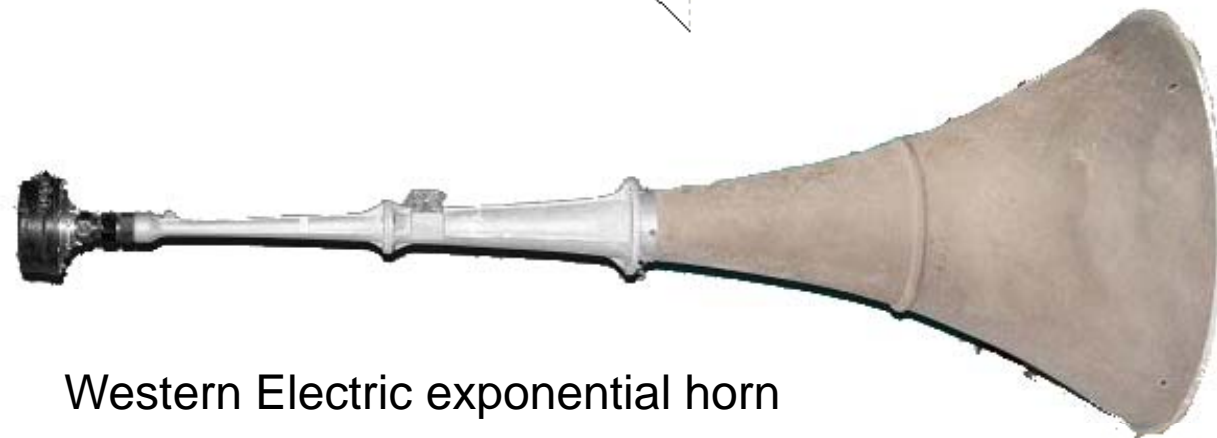
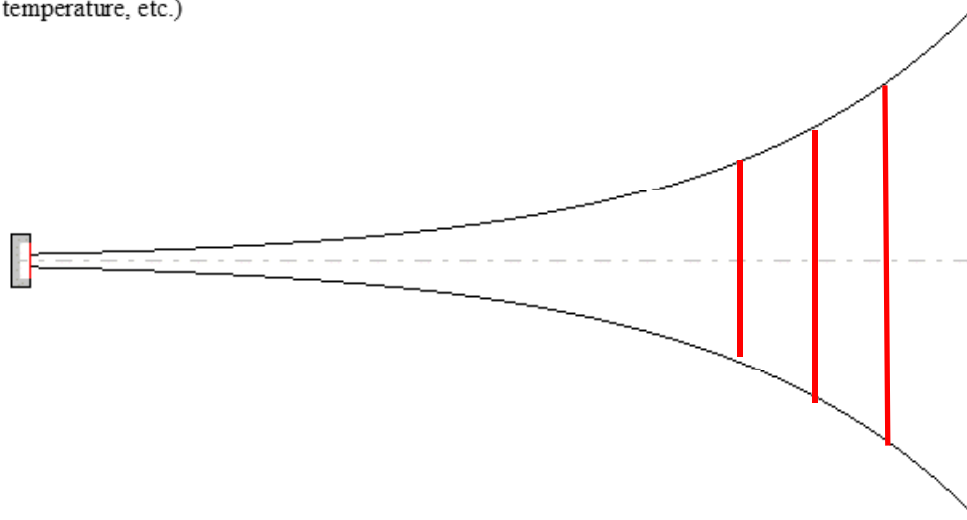

Western Electric exponential horn

$$Ax = Ah \left(\cosh \frac{x}{x_0} + T \sinh \frac{x}{x_0} \right)^2$$

Normal range
of T value
between
0 and 1
← →

For $T \gg 1$ the profile becomes progressively conical

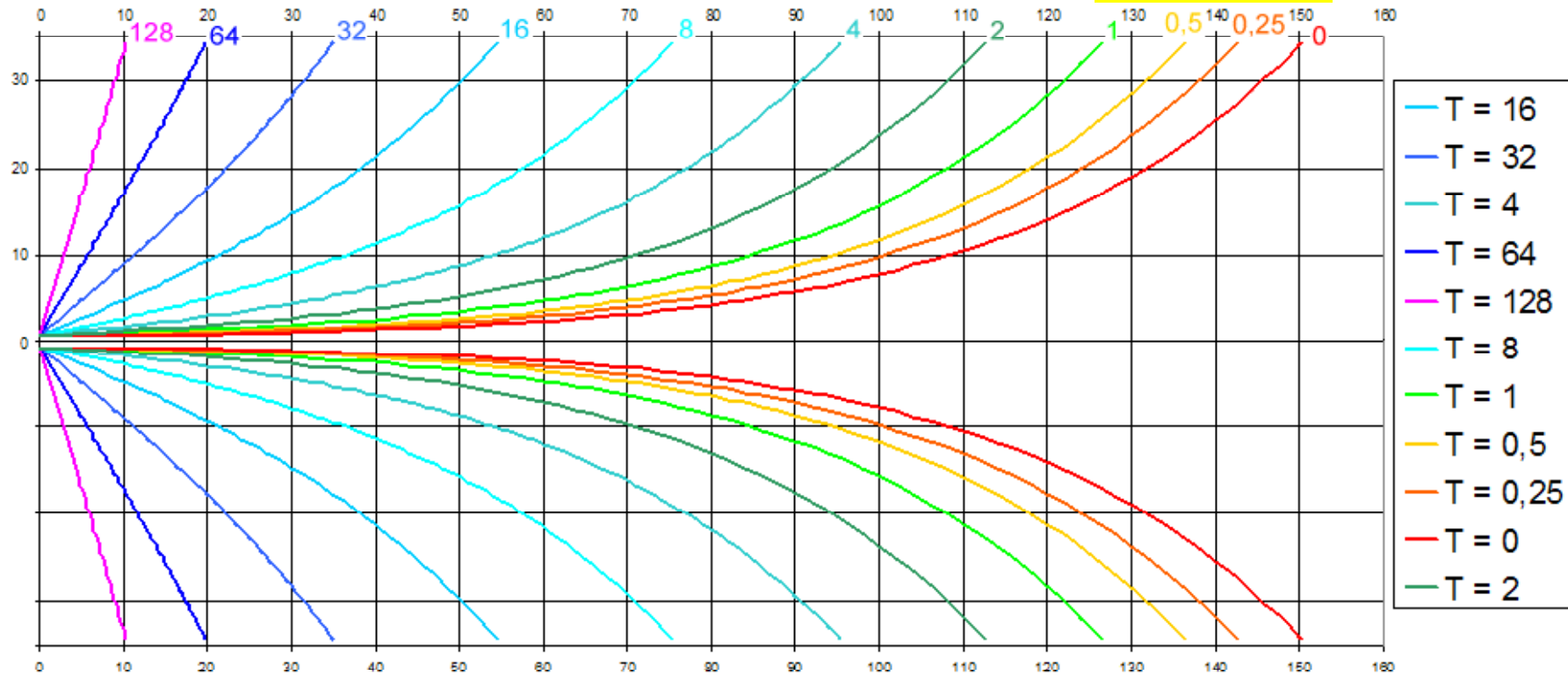

profiles of hyperbolic family horns with T value variation between 0 and 128

the Tractrix horn



Paul G.A.H. Voigt
(1902-1981)

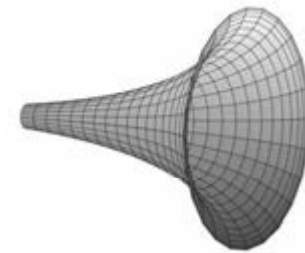
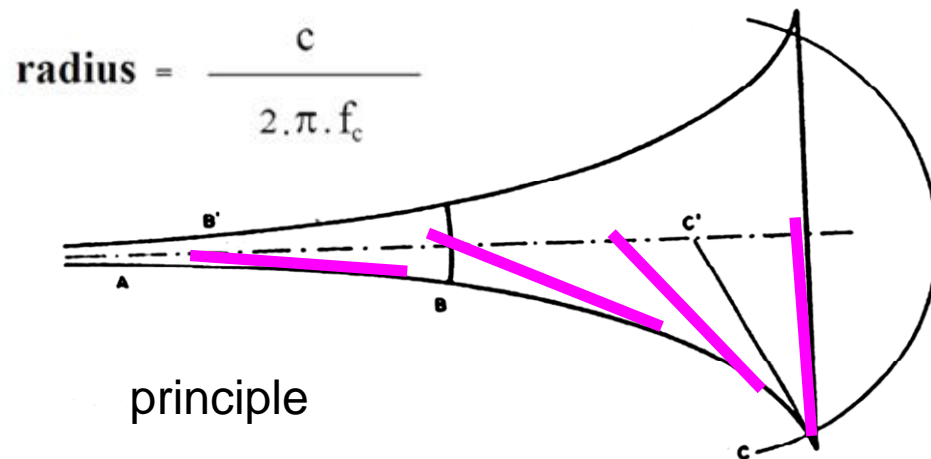

the mathematical pseudosphere

$$x = r_m \cdot \ln \left(\frac{r_m + \sqrt{r_m^2 - r_x^2}}{r_x} \right) - \sqrt{r_m^2 - r_x^2}$$

- x is the distance from the mouth
- r_m is the radius at the full Tractrix mouth (= $c / (2 * \pi * fc)$)
- r_x is the radius at distance x from the mouth

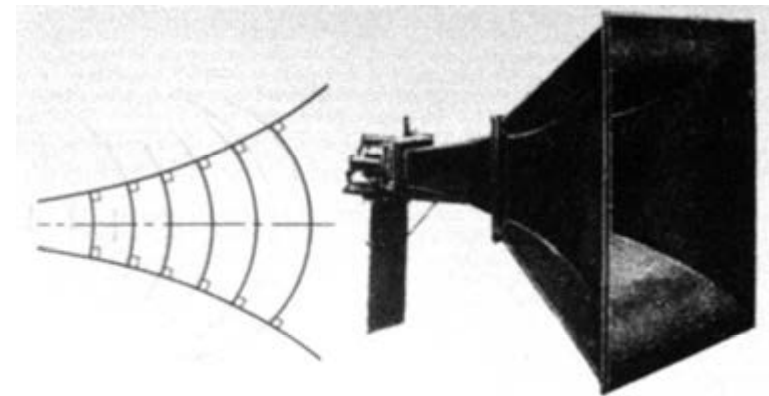

a square tractrix horn built by
Edison Bell in England

"The only way that he could figure out to make his driver sound good was to horn load it, but he couldn't understand the mathematics behind the exponential, so he said, "Well, the exponential theory predicts that the wave form going down the horn is plane or flat, but if you look at the physics of the situation, the wave front has to drag along the horn walls. So naturally it's going to be curved. What if I geometrically designed a horn that has curved wave fronts all the way through the horn and see what happens?"

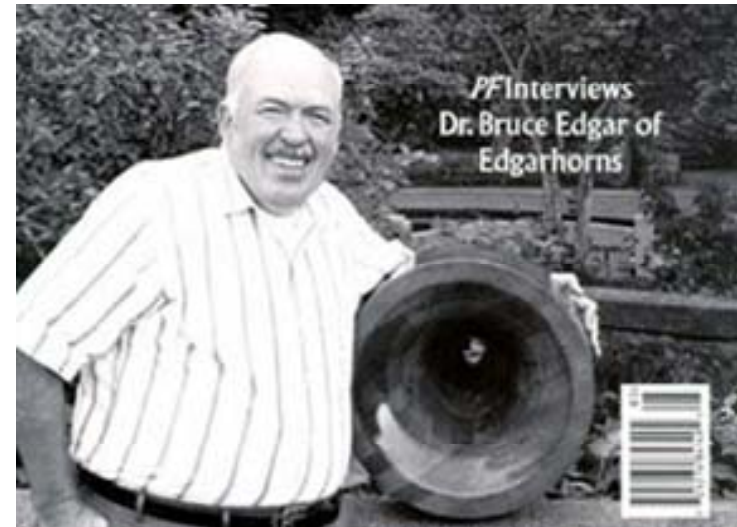

So he did a geometrical construction of a horn that would give him curved wave fronts. *He said that a draftsman looked at what he had done and said, "Oh, that's a Tractrix curve."* The Tractrix curve comes about because if you have one airplane chasing another on a different course, then the chase plane has to change his course to intercept the other plane, and it turns out that's a Tractrix curve."

Bruce Edgar on Voigt's tractrix

expansion law of the Tractrix horn

$$A = 2 \pi R h = 2 \pi R^2 [1 - \cos(\alpha)]$$

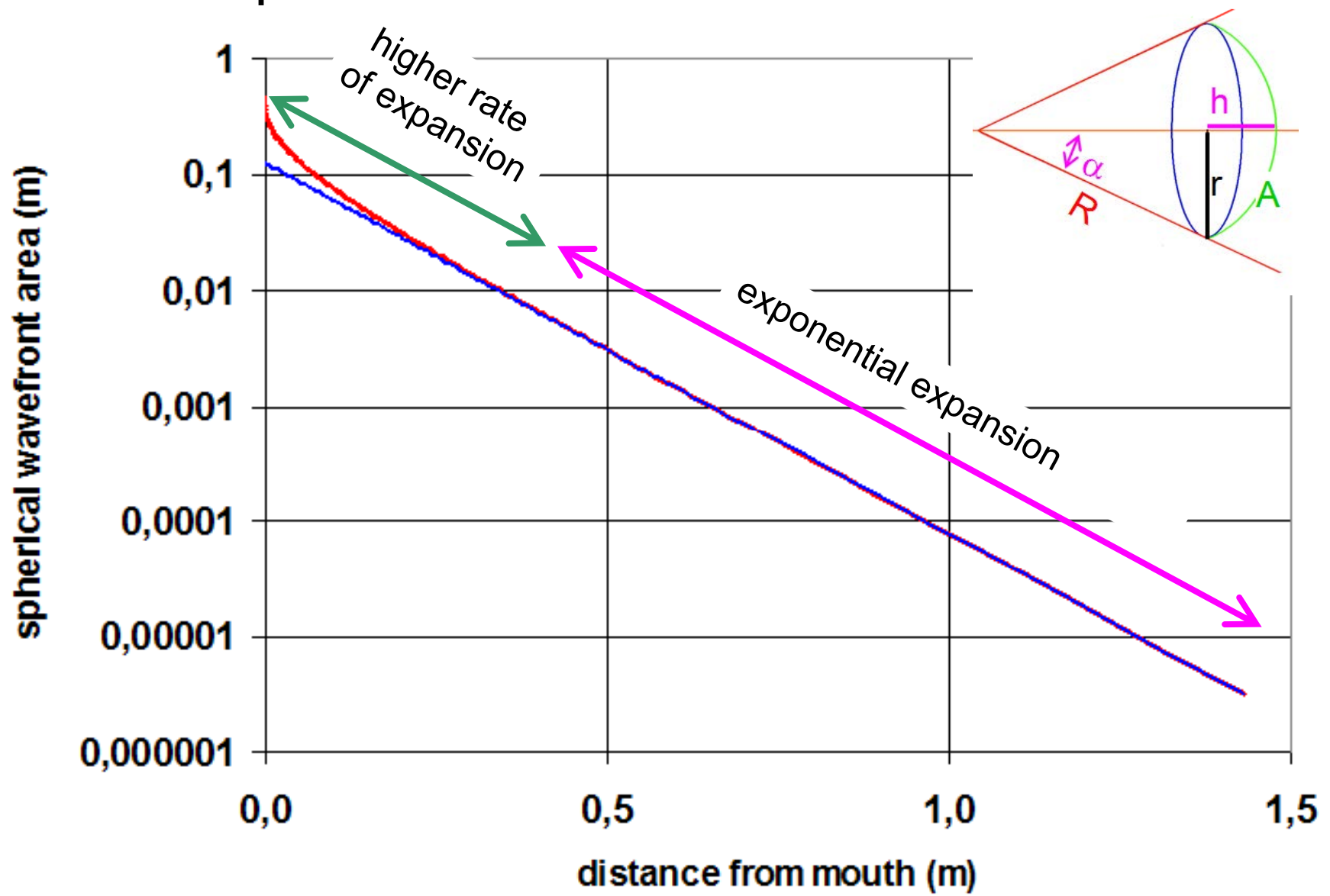

Kugelwellen

Rösch (KLANGFILM laboratories)

radius is the double of the radius used in the tractrix horn

Kalotte annimmt. Bei gleicher Schallausbreitungsgeschwindigkeit muß ja in der Tat der Wellenteil in der Nähe der Achse weiter vordringen, als der

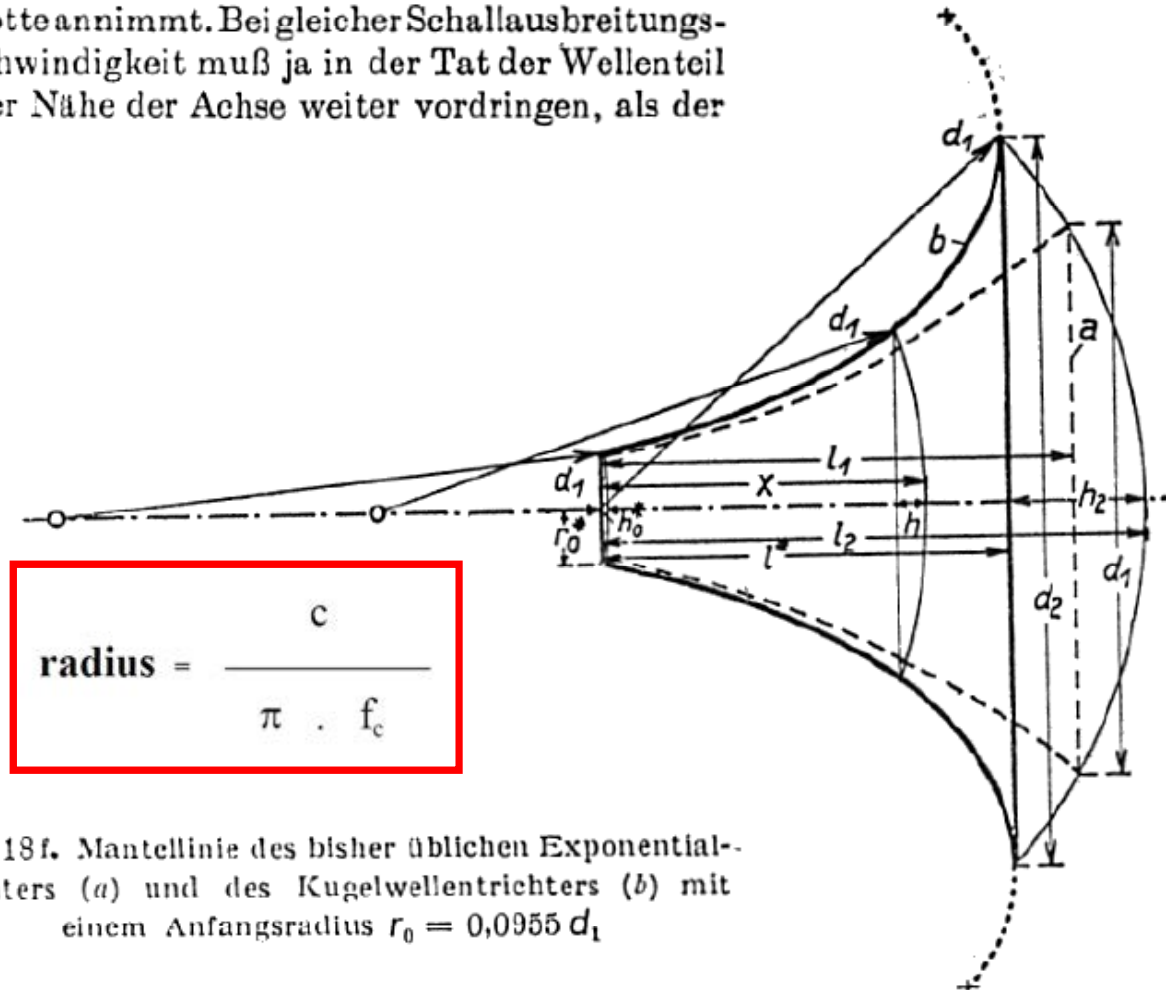

$$\text{radius} = \frac{c}{\pi \cdot f_c}$$

Bild 18f. Mantellinie des bisher üblichen Exponentialtrichters (a) und des Kugelwellentrichters (b) mit einem Anfangsradius $r_0 = 0,0955 d_1$

see also : H.Schmidt: "Über eine neue Lautsprecherkombination" Funk und Ton N°5, 1950, p.226-232

Kugelwellen

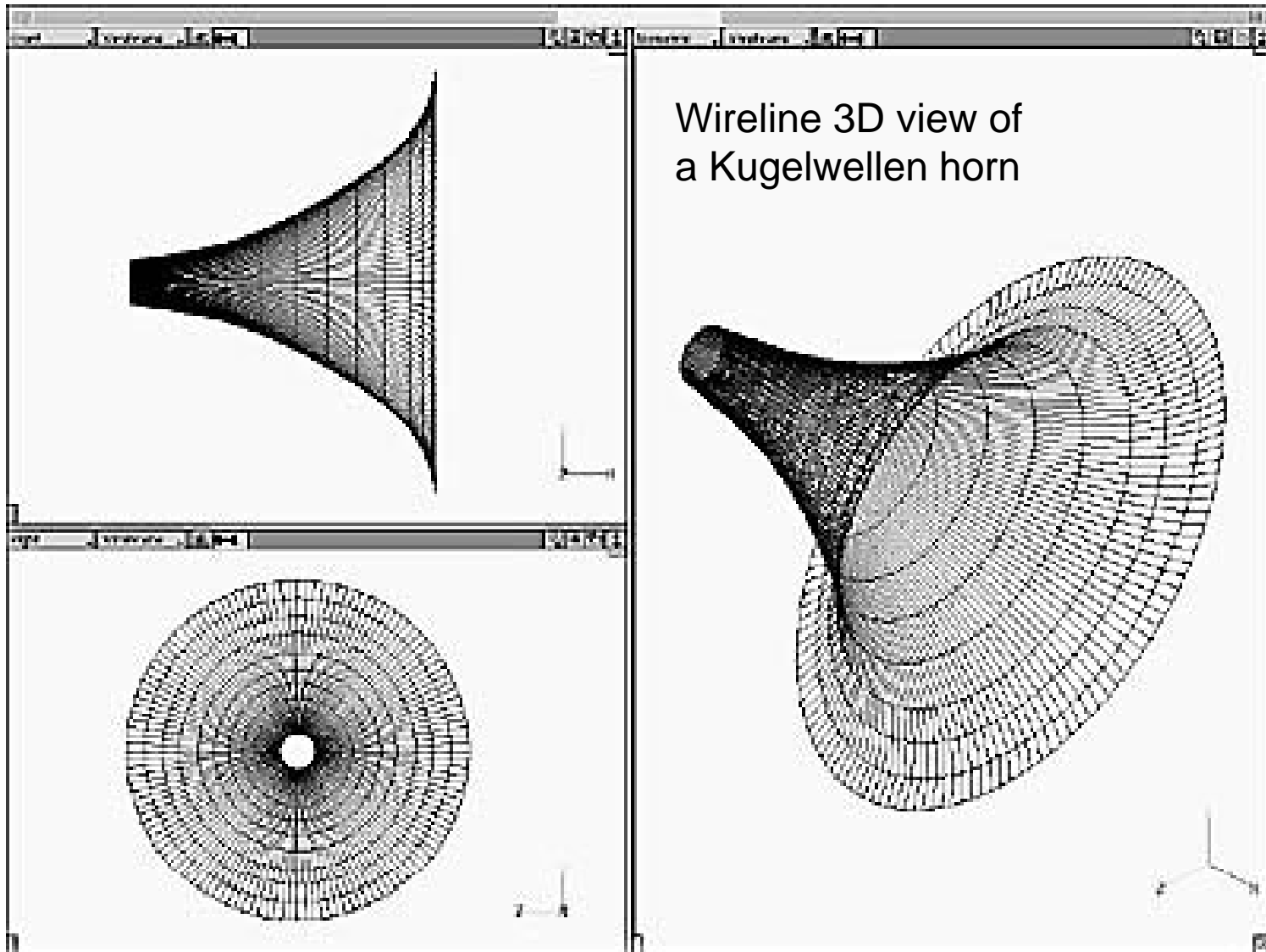

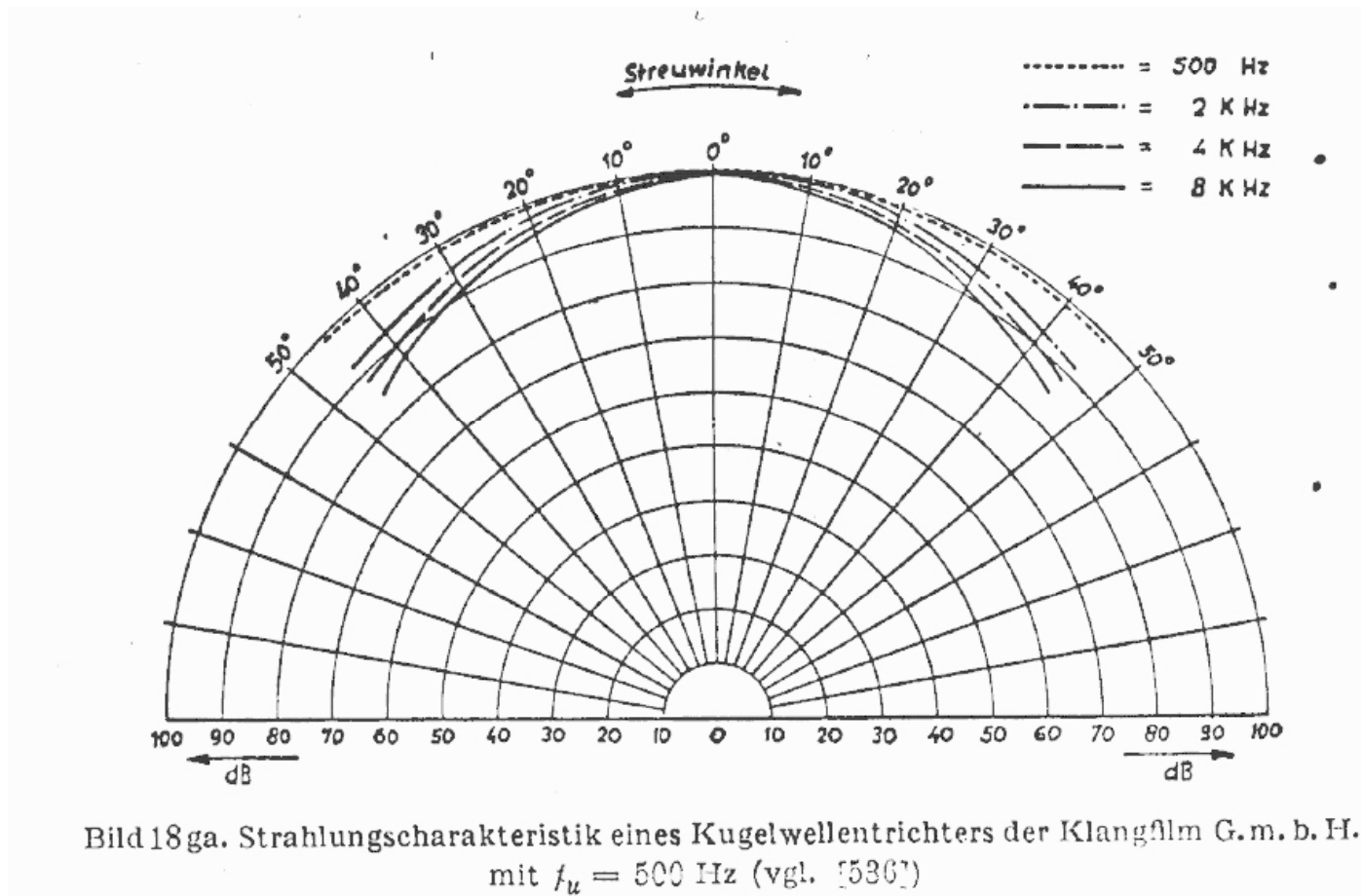

radiation diagram of the Kugelwellen horn

"Le Cléac'h" horn



Le Cléac'h's method to calculate the profile of an horn knowing the relation between the area of the wavefront and its distance to throat

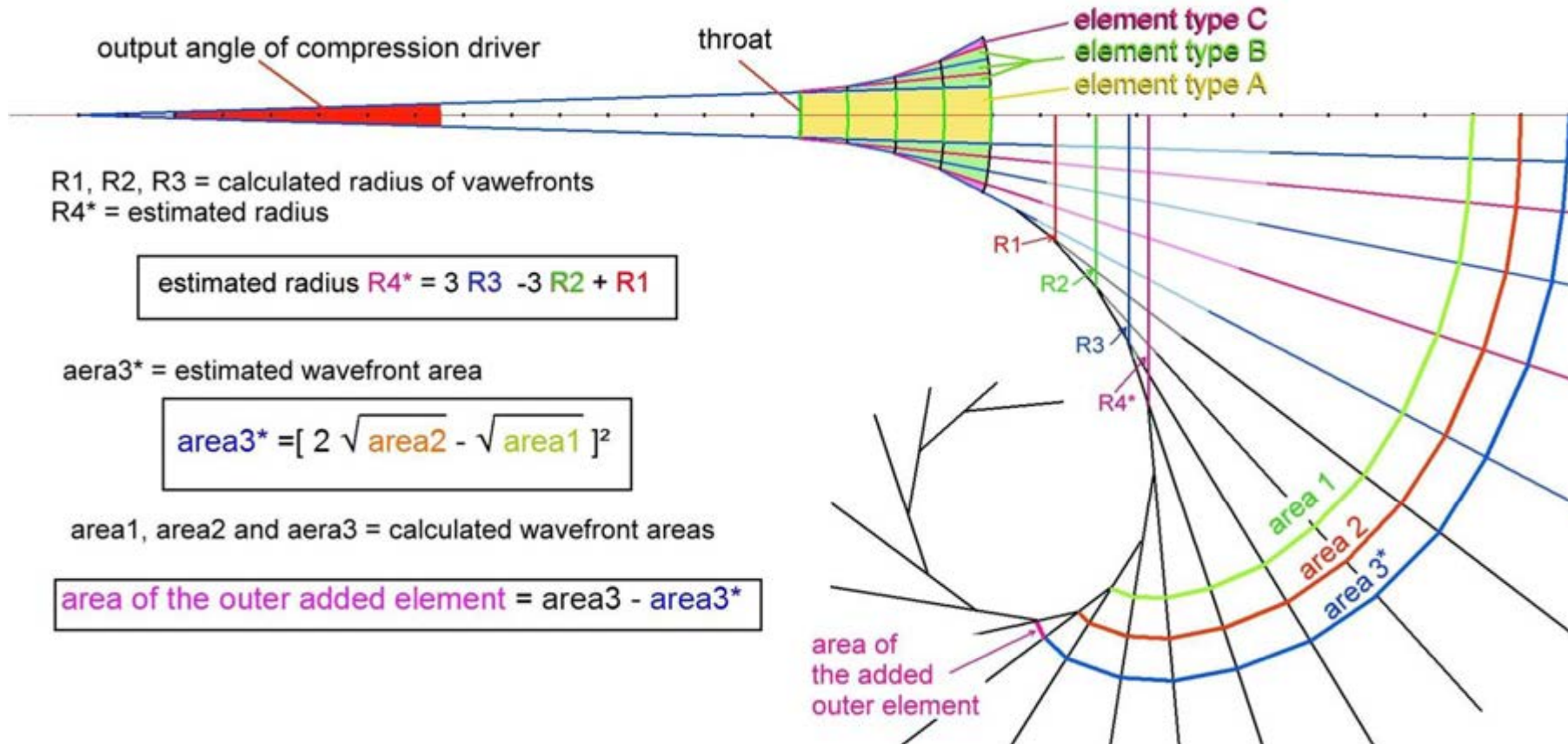

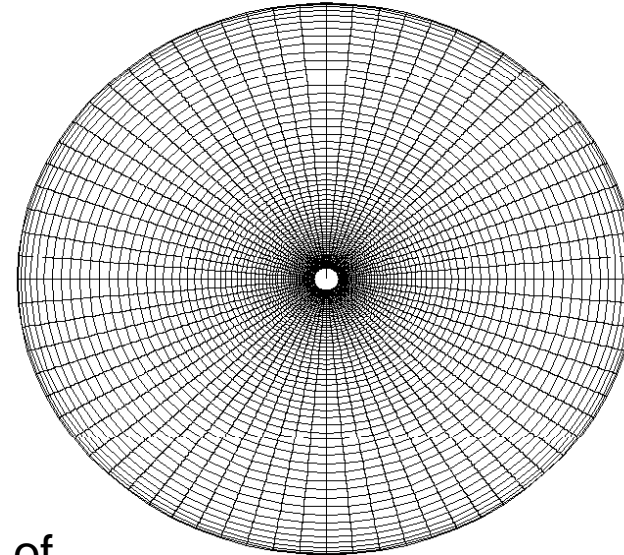
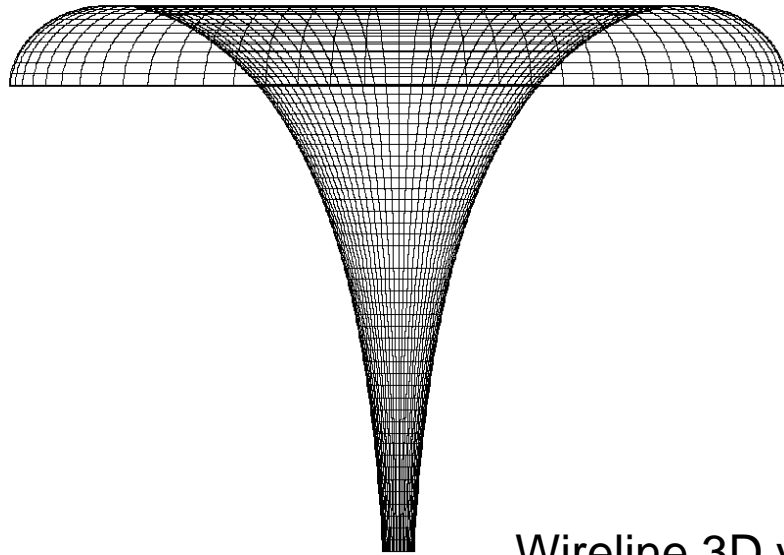

Wireline 3D view of
a Le Cléac'h horn

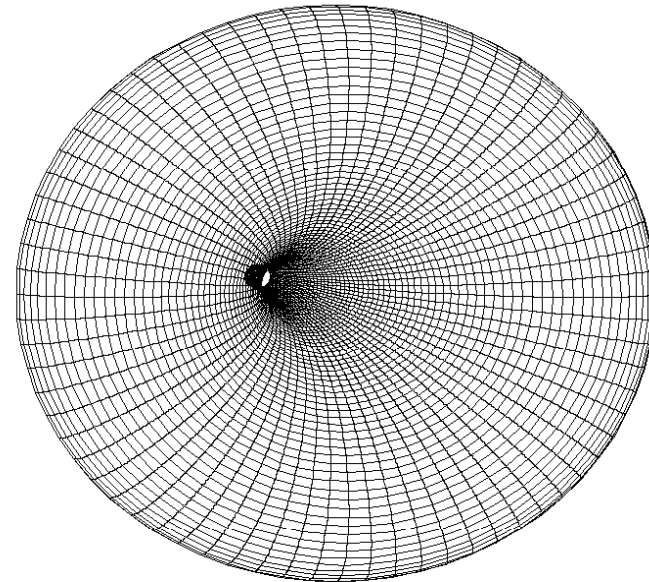
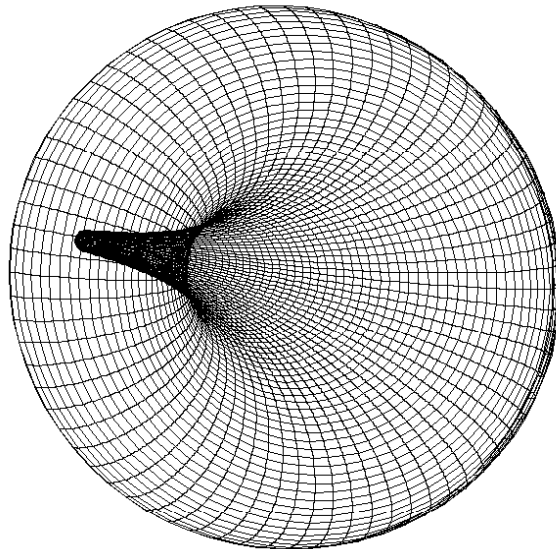

Le Cléac'h horns (JMLC) that compromise superb pressure linearity, good bass extension, and time domain behavior. Below example with TAD2001

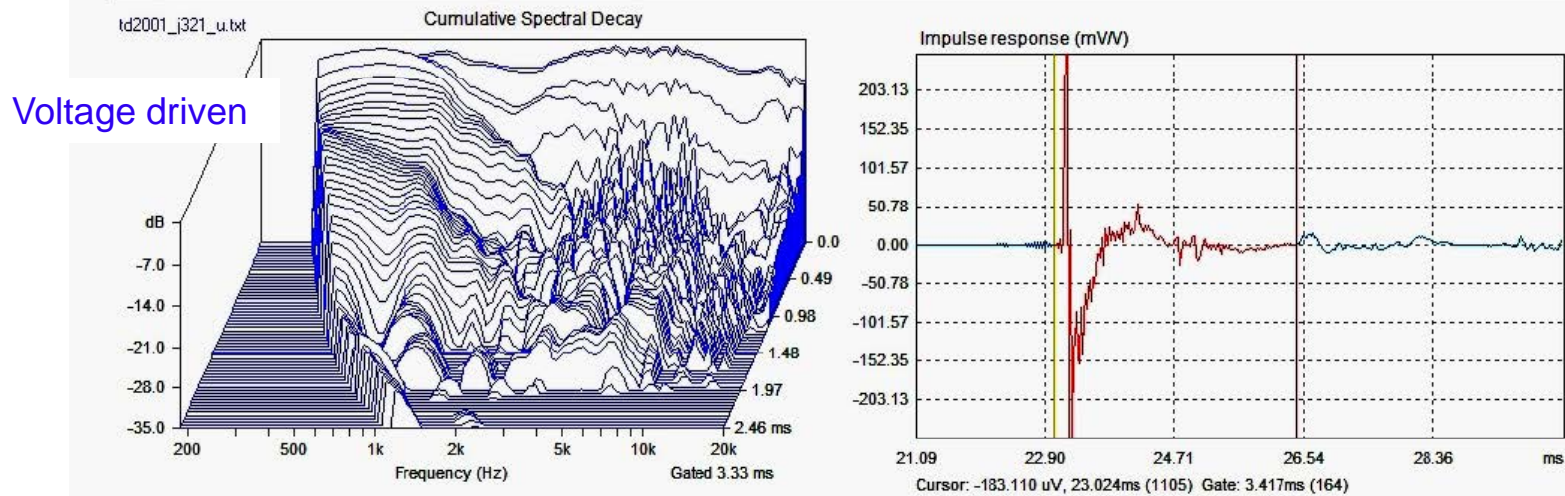
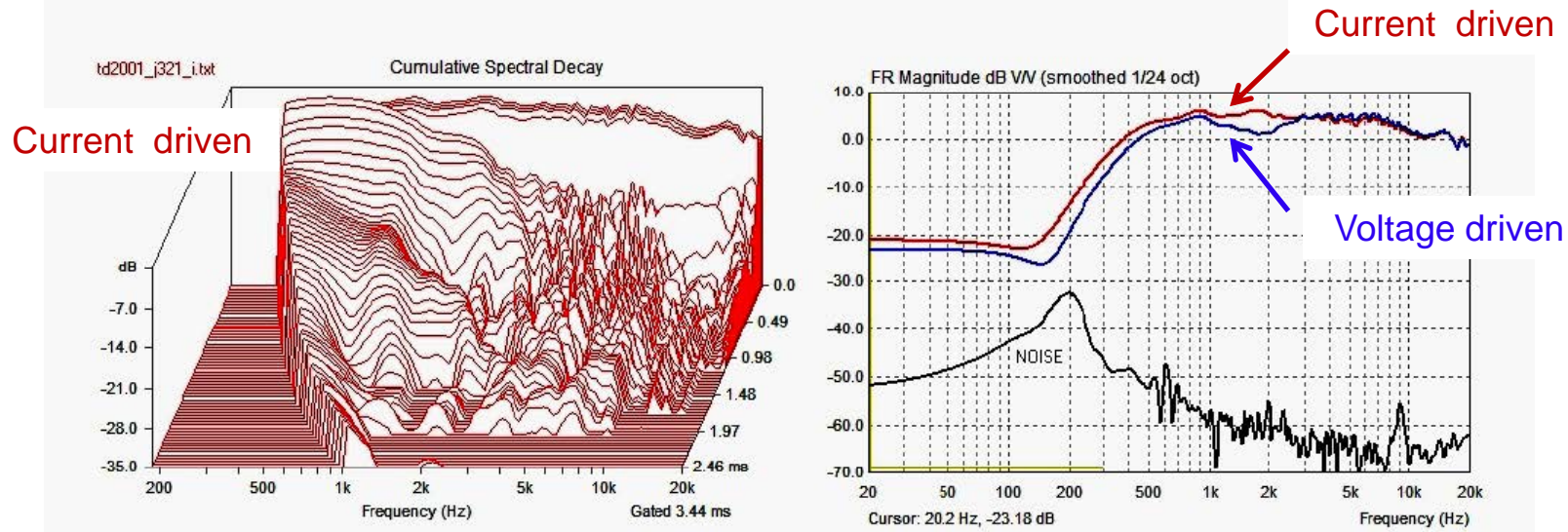

analysis by Jacek Zagaja

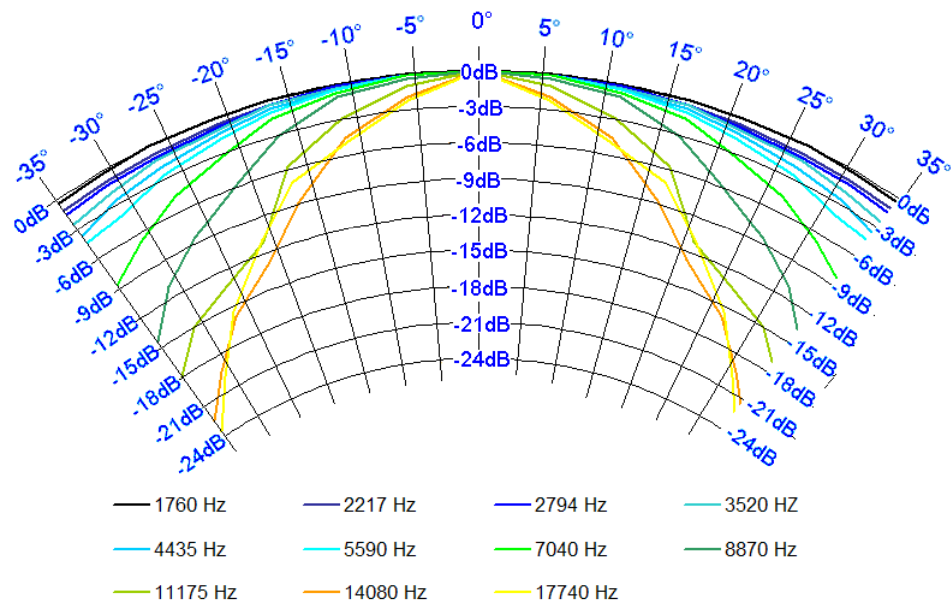

J321 ($F_c = 320\text{Hz}$)

directivity pattern of few
Le Cléac'h horns

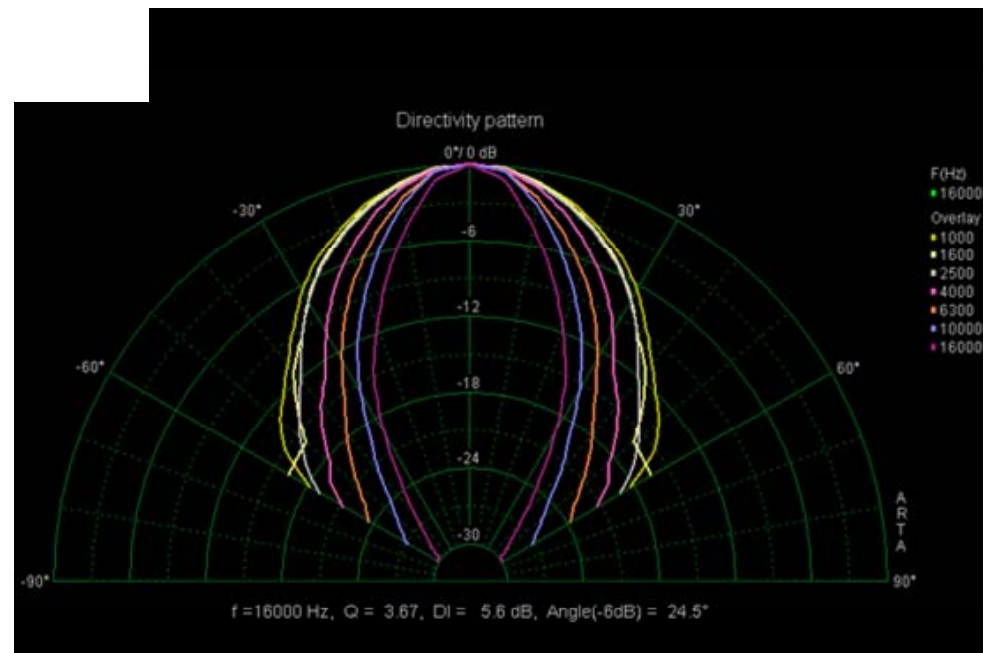

J871 ($F_c = 870\text{Hz}$)

compared profiles of exponential, spherical, Le Cléac'h,
Kugelwellen, tractrix, tractrix revisited

*Note how the profiles of the Kugelwellen
and Le Cléac'h horns are very similar*

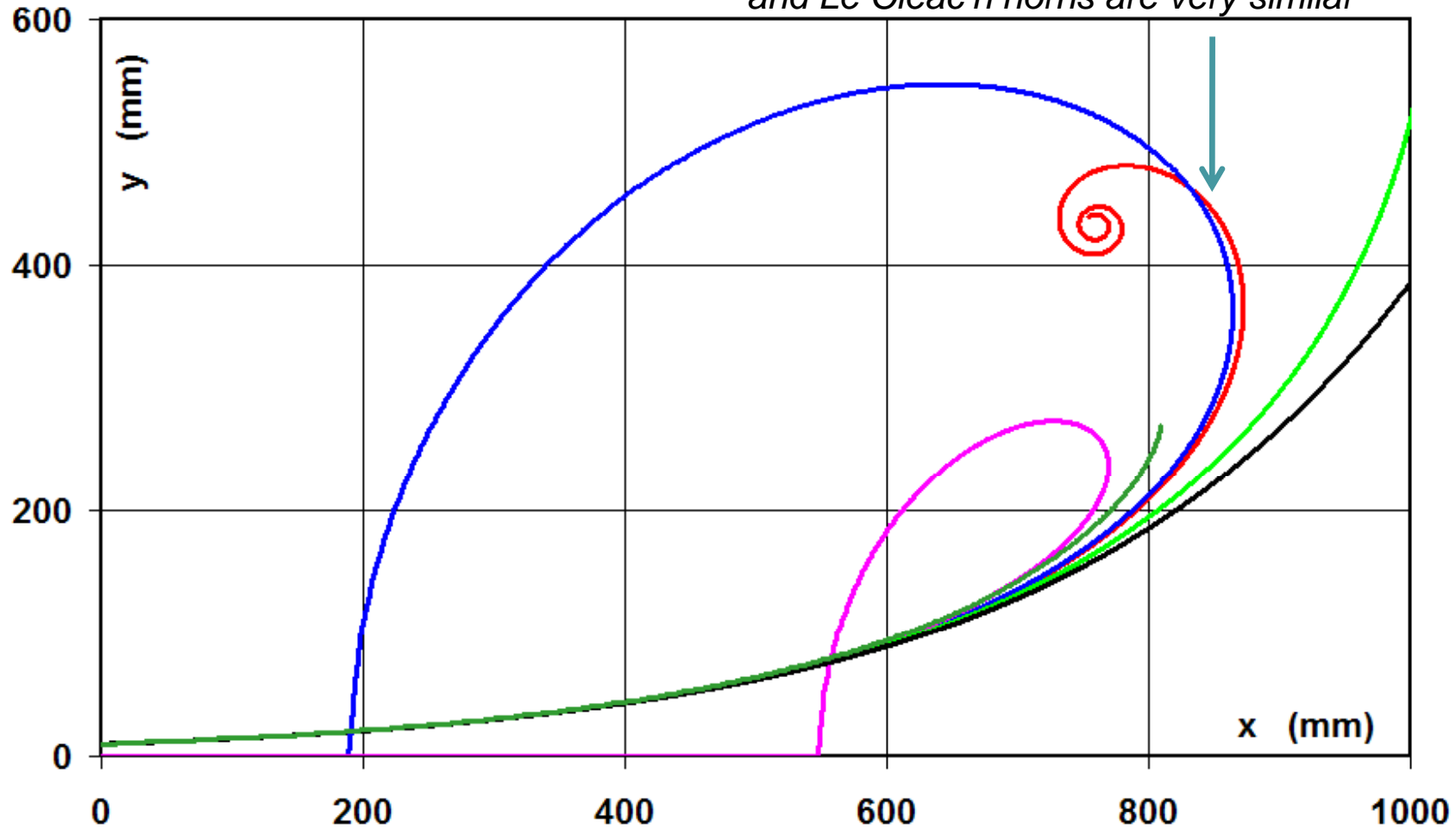

waveguides

The benefits of the directivity of a waveguide are improved frequency response and SPL levels within the included angle of the waveguide within the operating frequency band of the waveguide.

In addition, sidewall and floor bounce reflections are reduced by the controlled directivity

conical horn

The simple formula for a conical horn is:

$$S = S_1 x^2$$

S = the area at the horn mouth

S_1 = the area at the horn throat

x = the length of the horn

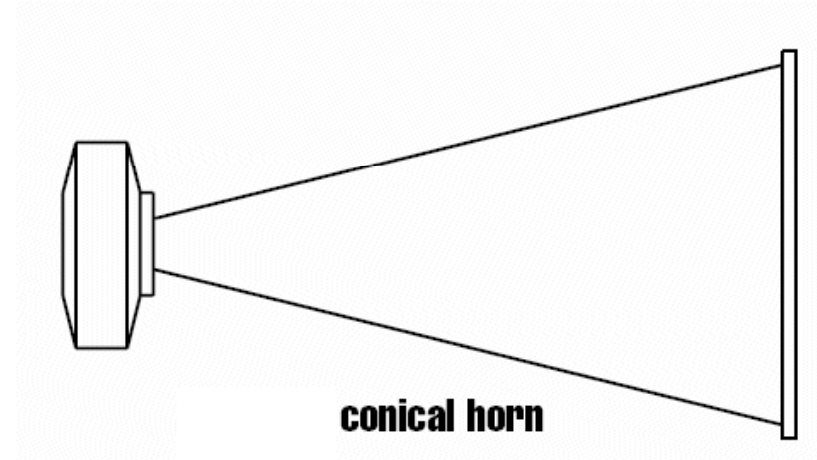

Oblate spheroidal waveguide

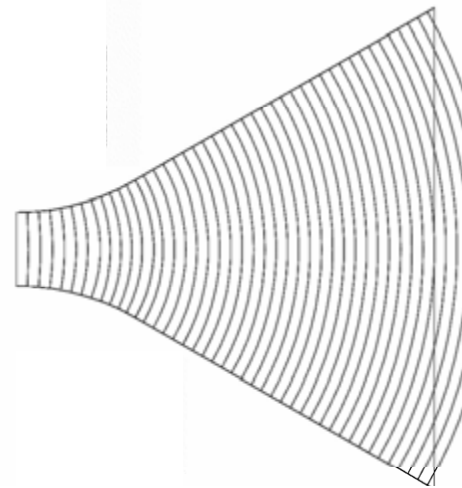
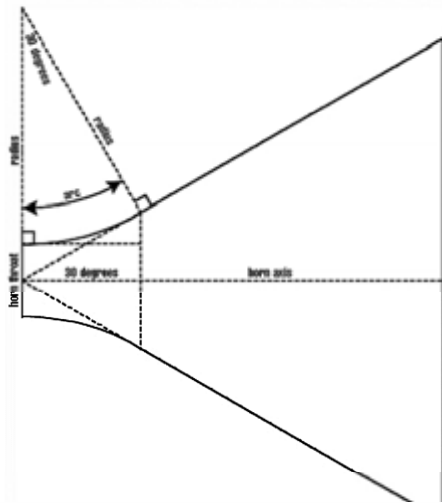

$$S = Ax^2 + B\sqrt{r^2 - x^2} + C$$



Earl Geddes

"The concept of a waveguide as a direct solution to the wave equation was shown to be capable of exact solution, free of the plane wave assumption of Webster's equation. "

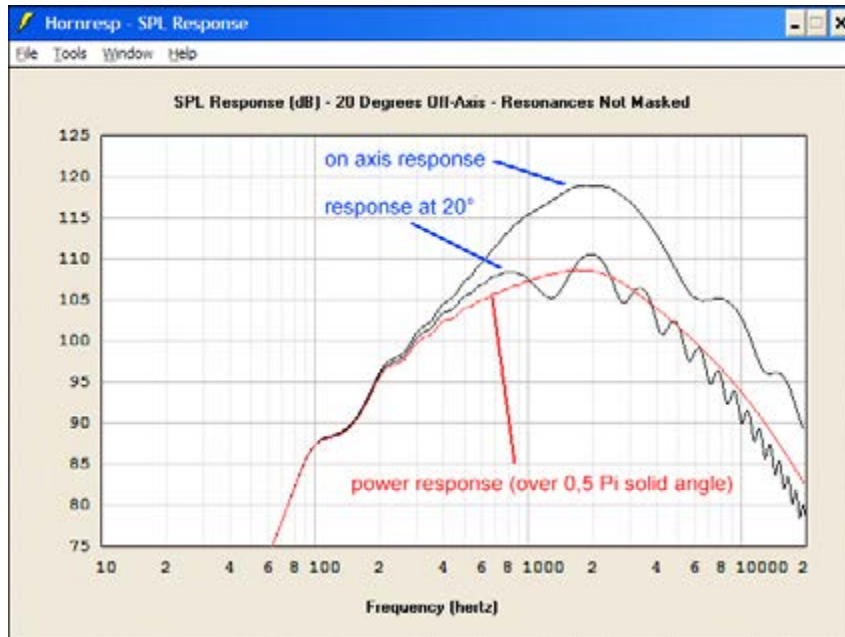

While the summed power response radiated by the OS waveguide in full space is very smooth, the frequency response curve at any given angle from the axis is never smooth

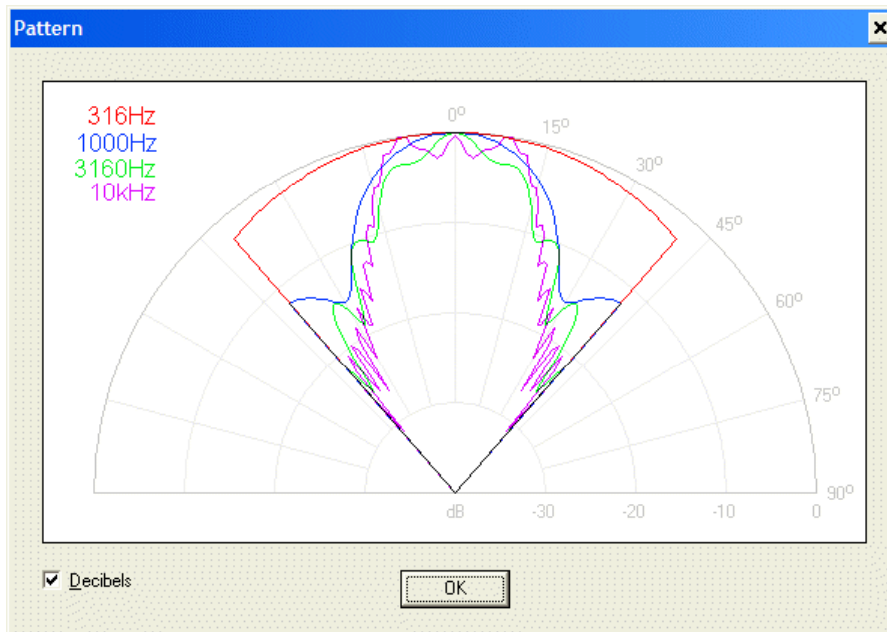

See measurements of Earl Geddes loudspeaker on page 123.

modelling and simulation of horns

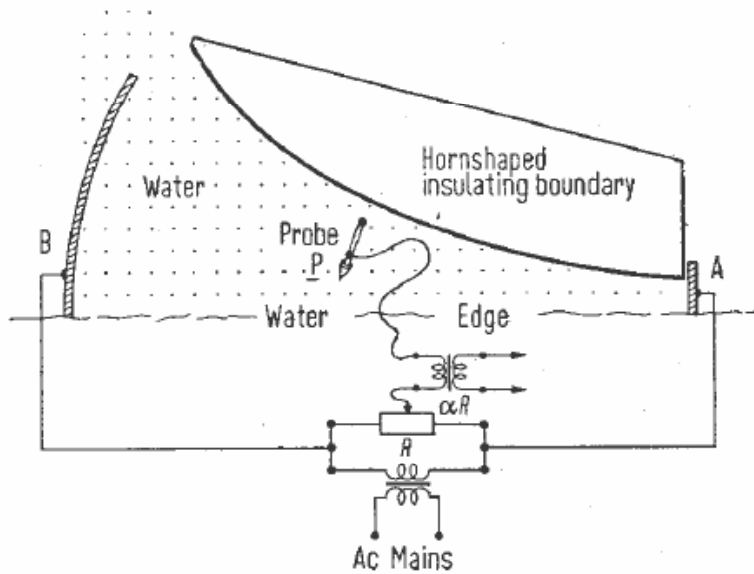

Fig. 4. Schematic diagram of an electrolytic tank field-plotting apparatus provided with a wedge-shaped volume of water. The equipotentials of the electric field are analogous to the low frequency flow equipotentials in an air filled horn.

above: the first models used a tank filled of water.

on right : later finite elements methods were used

Shape optimization of an acoustic horn

Erik Blågtorn, Daniel Noreland, and Martin Berggren
Department of Information Technology
Uppsala University
P.O. Box 1229
SE-751 21 Uppsala, Sweden
May 8, 2002

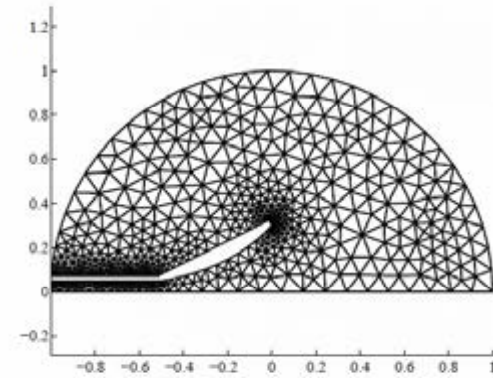

FIGURE 7: The finite element mesh, denoted Mesh I in table 2, on the initial geometry. Note that the Γ_d^{int} is different from Γ_d^{ref} .

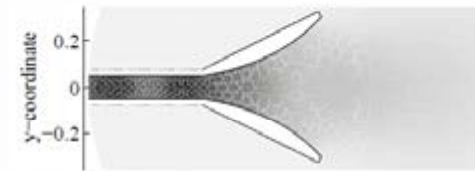

FIGURE 8: The square of the absolute value of the initial sound pressure in the horn, the waveguide, and the surroundings. Note the banded pattern in the waveguide, indicating reflections.

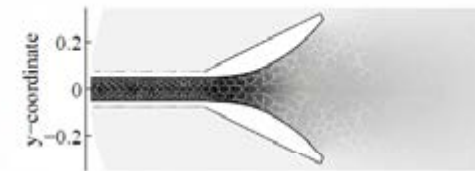

FIGURE 12: The square of the absolute value of the sound pressure distribution at 550 Hz after optimization. Note that the banded structure in the waveguide shown in figure 8 has disappeared.

Acoustic Radiation of a Horn Loudspeaker by the Finite Element Method—A Consideration of the Acoustic Characteristic of Horns*

SHIGERU MORITA, NOBORU KYONO, AND SHINICHI SAKAI
Consumer Products Research Laboratory, Mitsubishi Electric Corporation, Kamakura 247, Japan
 AND
 TATSUO YAMABUCHI AND YUKIO KAGAWA
Toyama University, Toyama, Japan

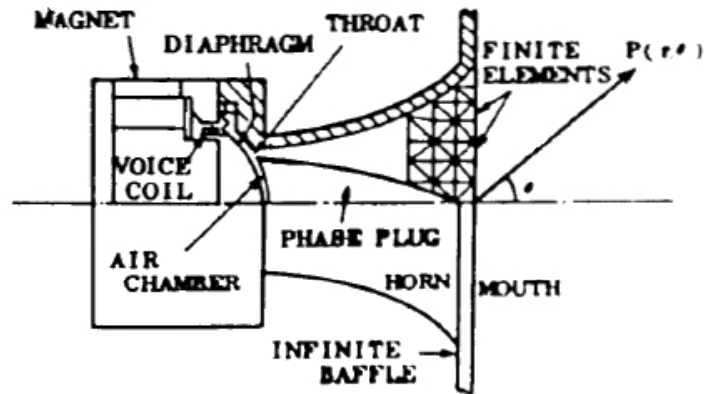

Fig. 1. Sectional view of a horn loudspeaker and finite element division.

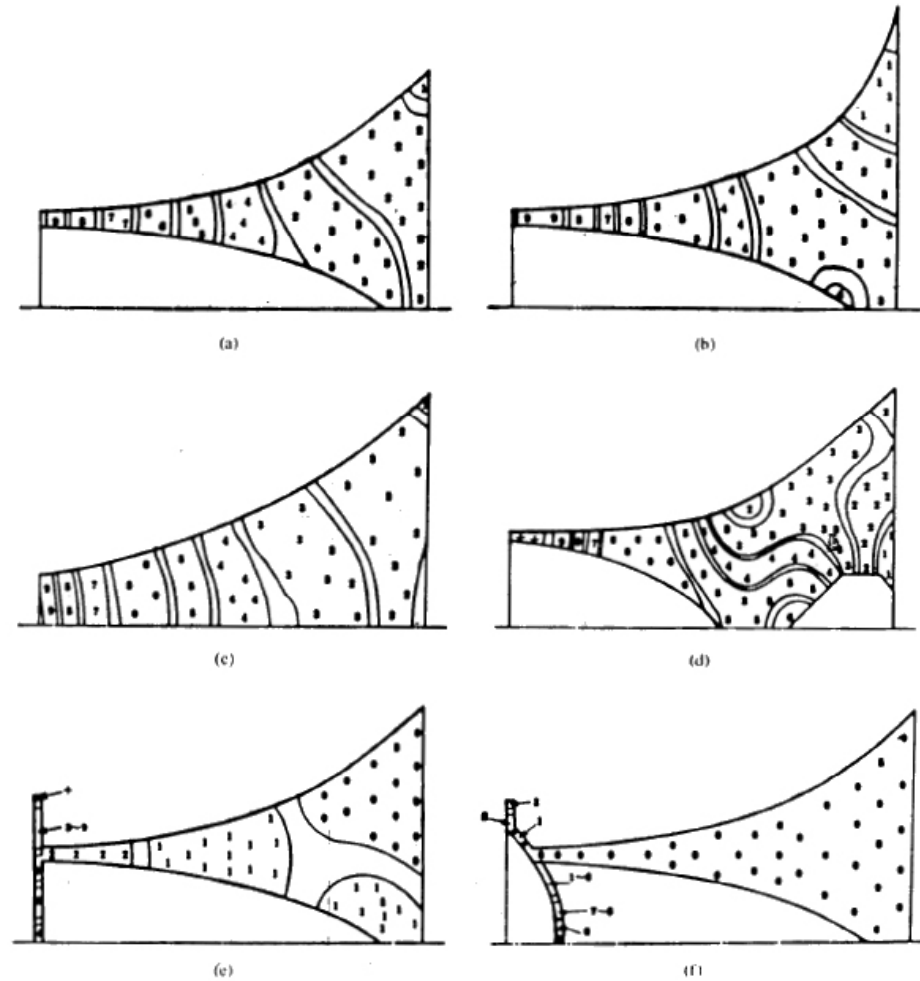
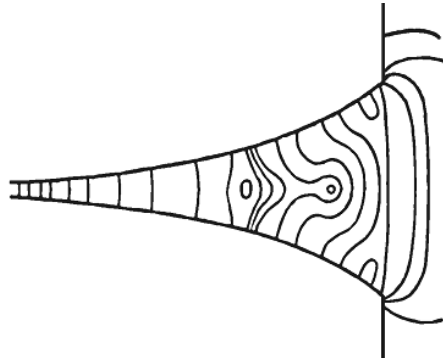
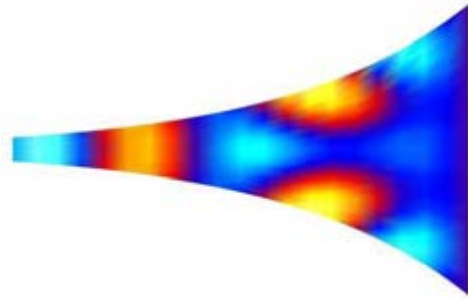

Fig. 8. Sound pressure distribution in the horns. (a) No. 1, frequency 10 kHz. (b) No. 2, frequency 11.7 kHz. (c) No. 3, frequency 10 kHz. (d) No. 4, frequency 12 kHz. (e) No. 5, frequency 12.8 kHz. (f) No. 6, frequency 12 kHz.

one of the first publication on FEM results of the simulation of soundfields in horns



Measurements performed by Morse



Finite elements analysis of an exponential horn by John Sheerin

Analysis using Cara performed by Michael Gertsgrasser

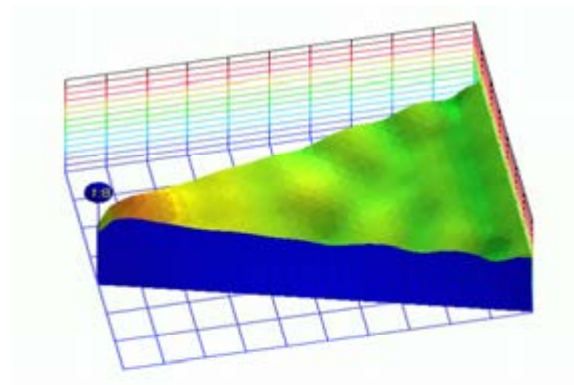

« wavetank » analysis in David McBean's Hornresp » software.

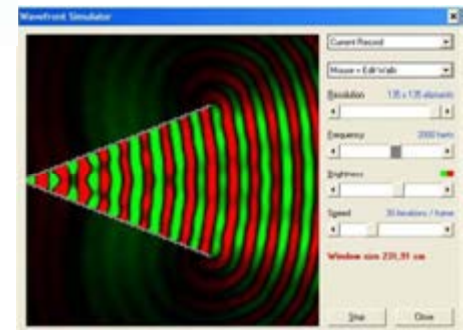

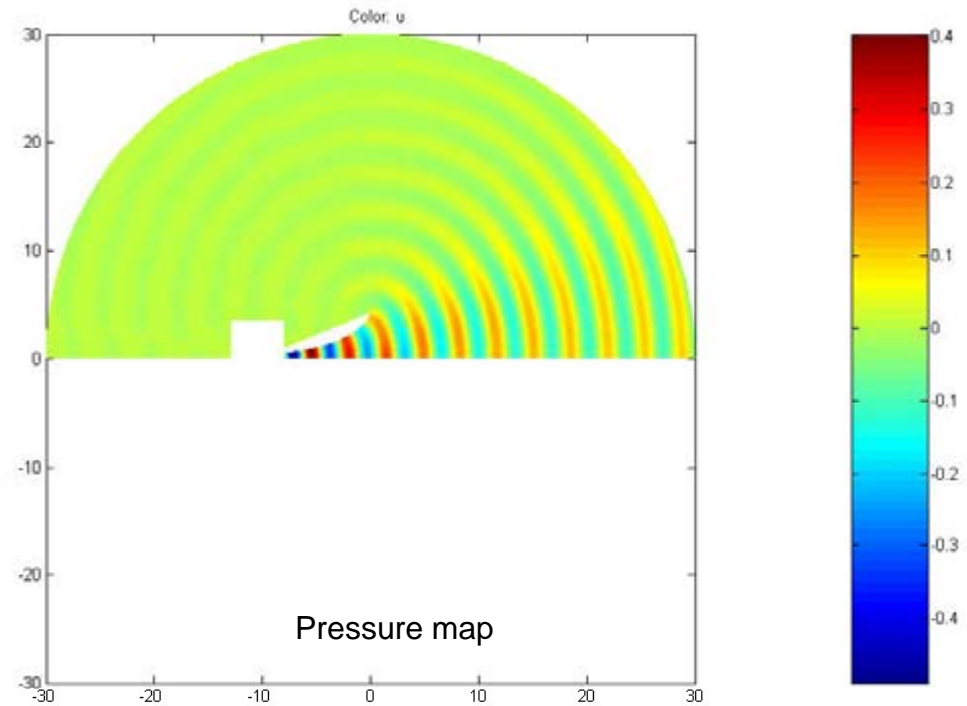
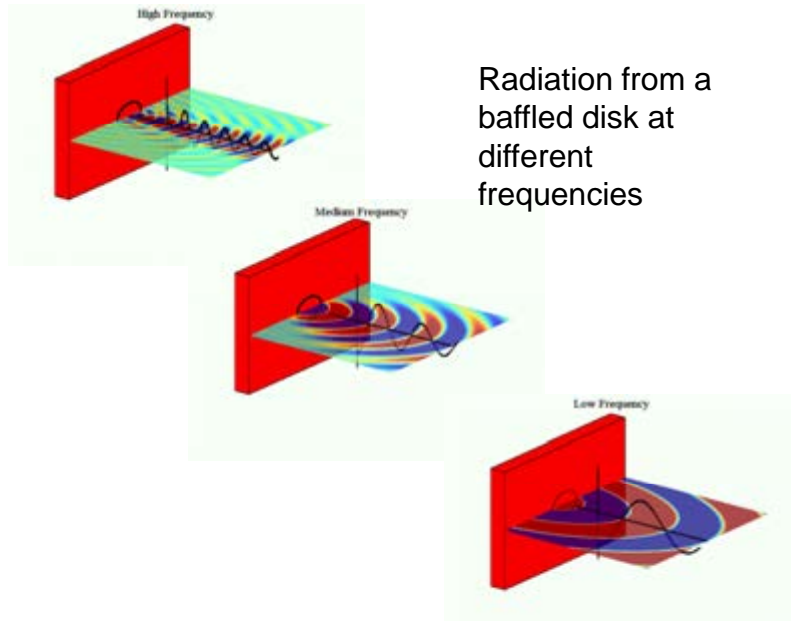

Copyright 2005, John H. Sheerin

Polar graph with a 3D presentation

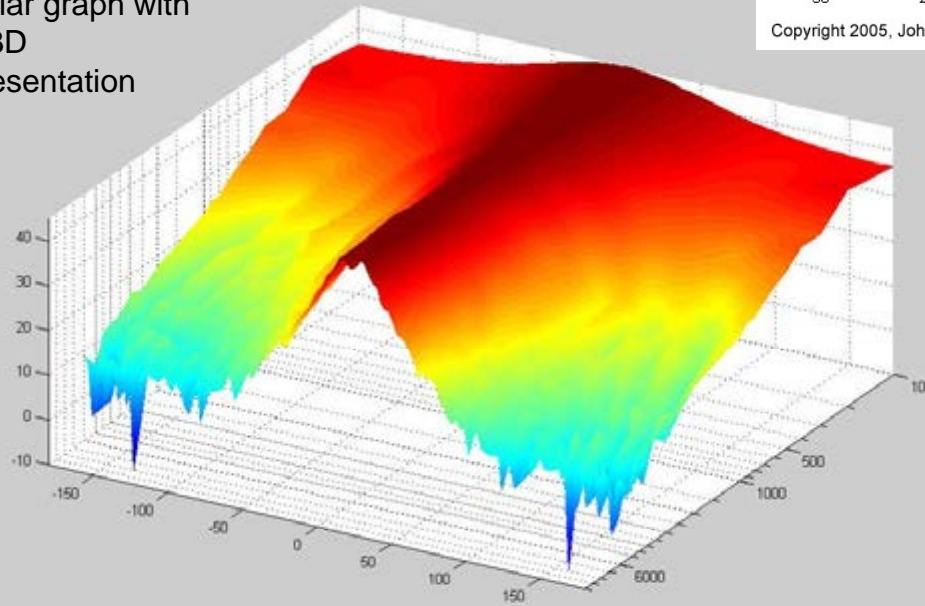

Copyright 2005, John H. Sheerin

Various simulations of the radiation of a piston and of a horn.

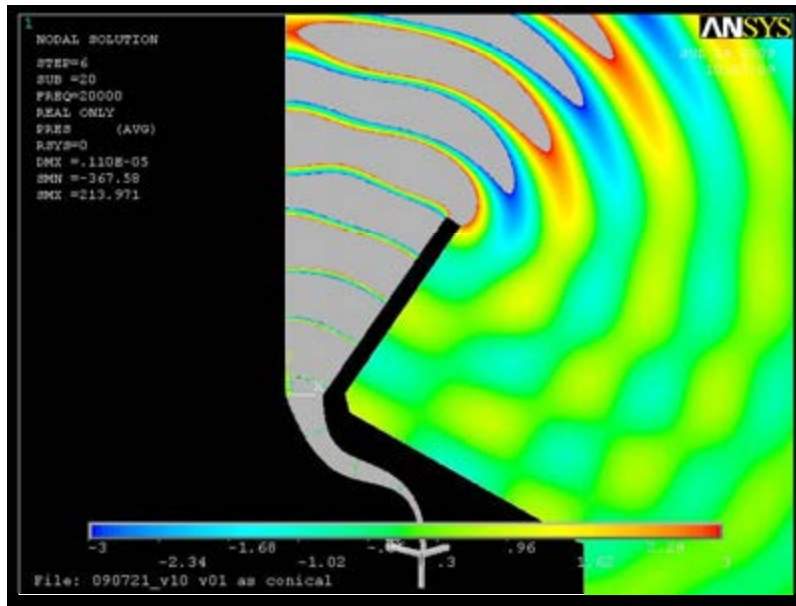

conical horn

Note the distortion of the shape of the wavefronts

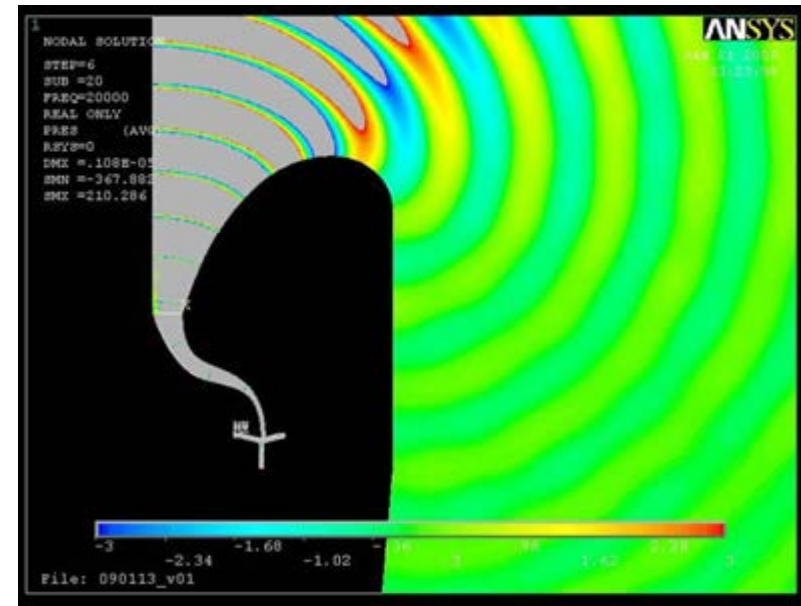

Le Cléac'h horn

Note the very smooth wavefronts

FEM simulations performed by John Sheerin

(Half horn represented only)

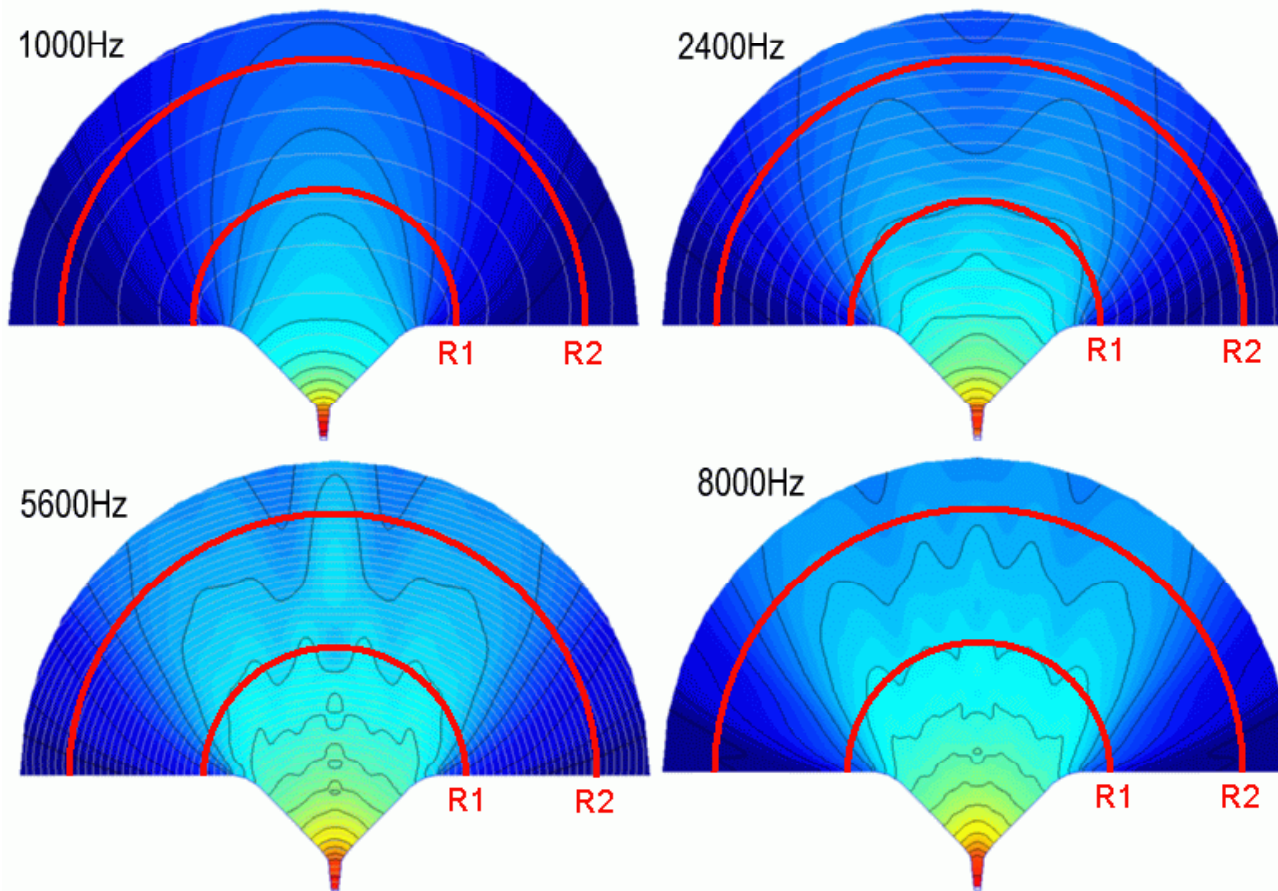

simulations of an OS waveguide at different frequencies

Note the wavy isobare curves over 2000Hz

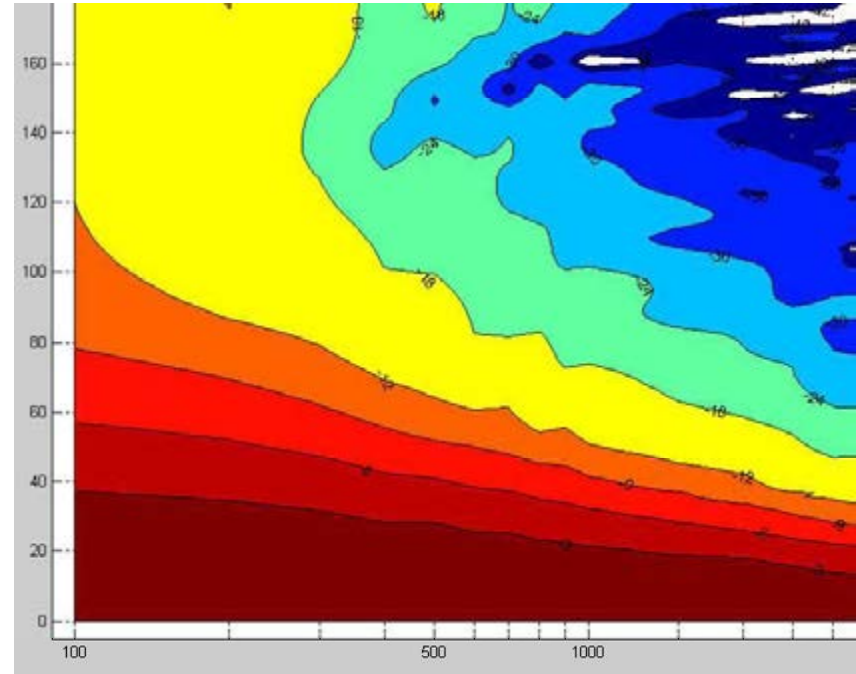
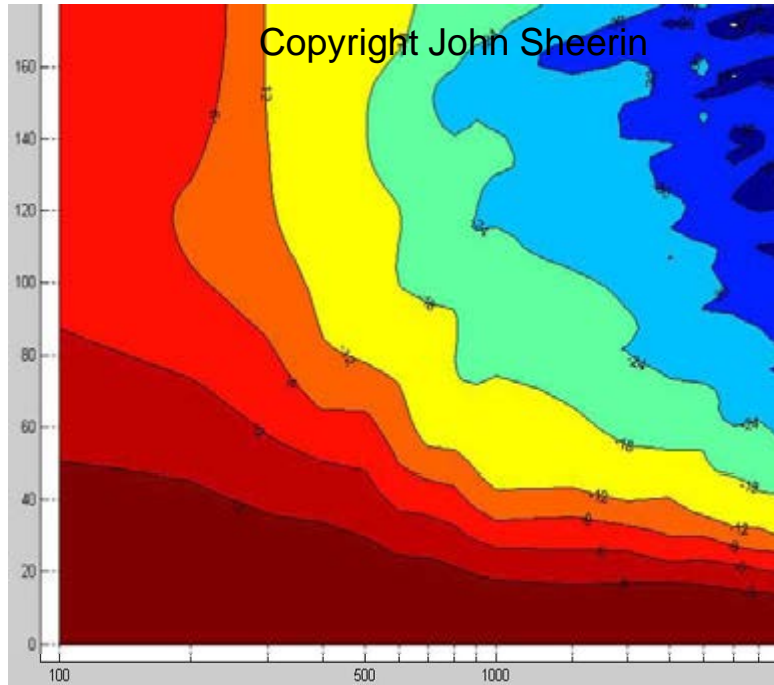

Note the smoothness and the linearity of the isolevel contours.

polars obtained by FEA of a 275Hz tractrix horn and a 275Hz Le Cléac'h horn

FEM simulations performed by John Sheerin

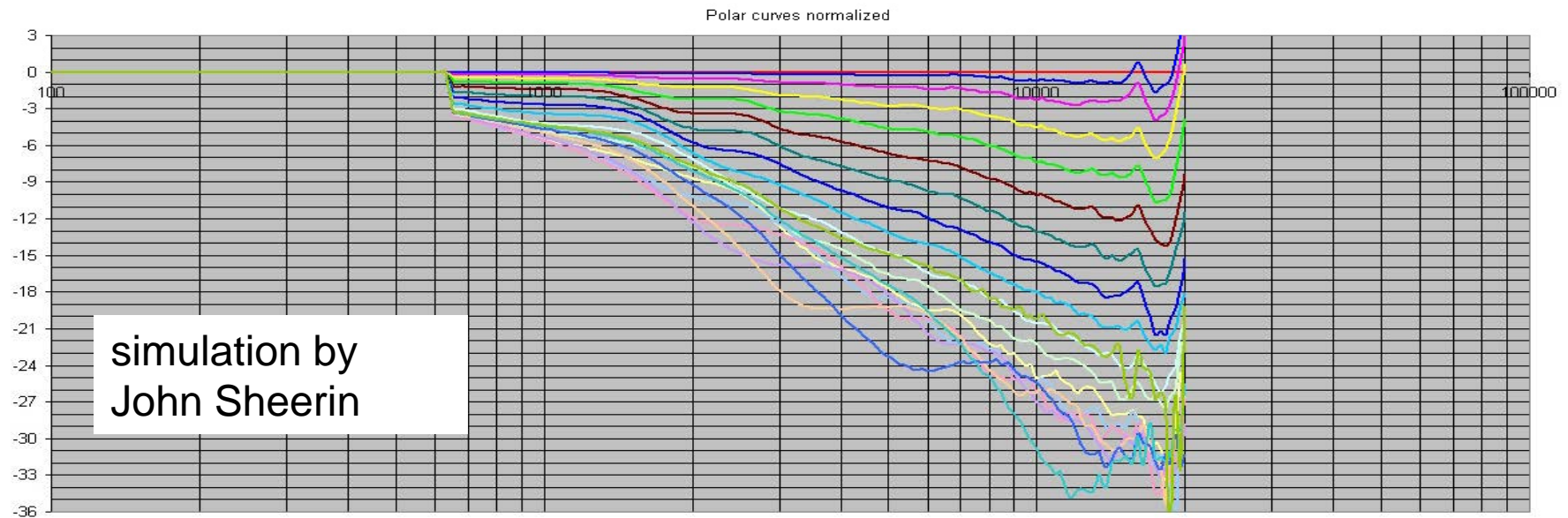

Note the smooth response curves off axis

my measurements on the J321 horn

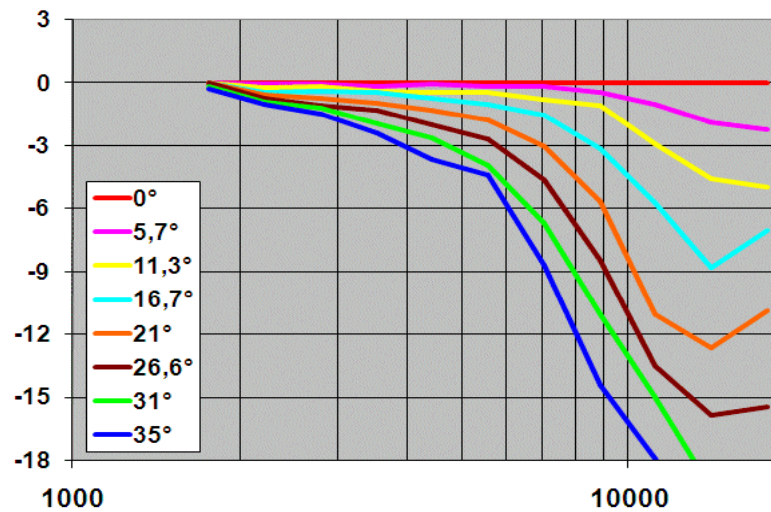

Le Cléac'h horn

backreflected waves,
High Order Modes (HOMs)
and stored energy

reflected waves
from mouth to
throat inside a
horn.

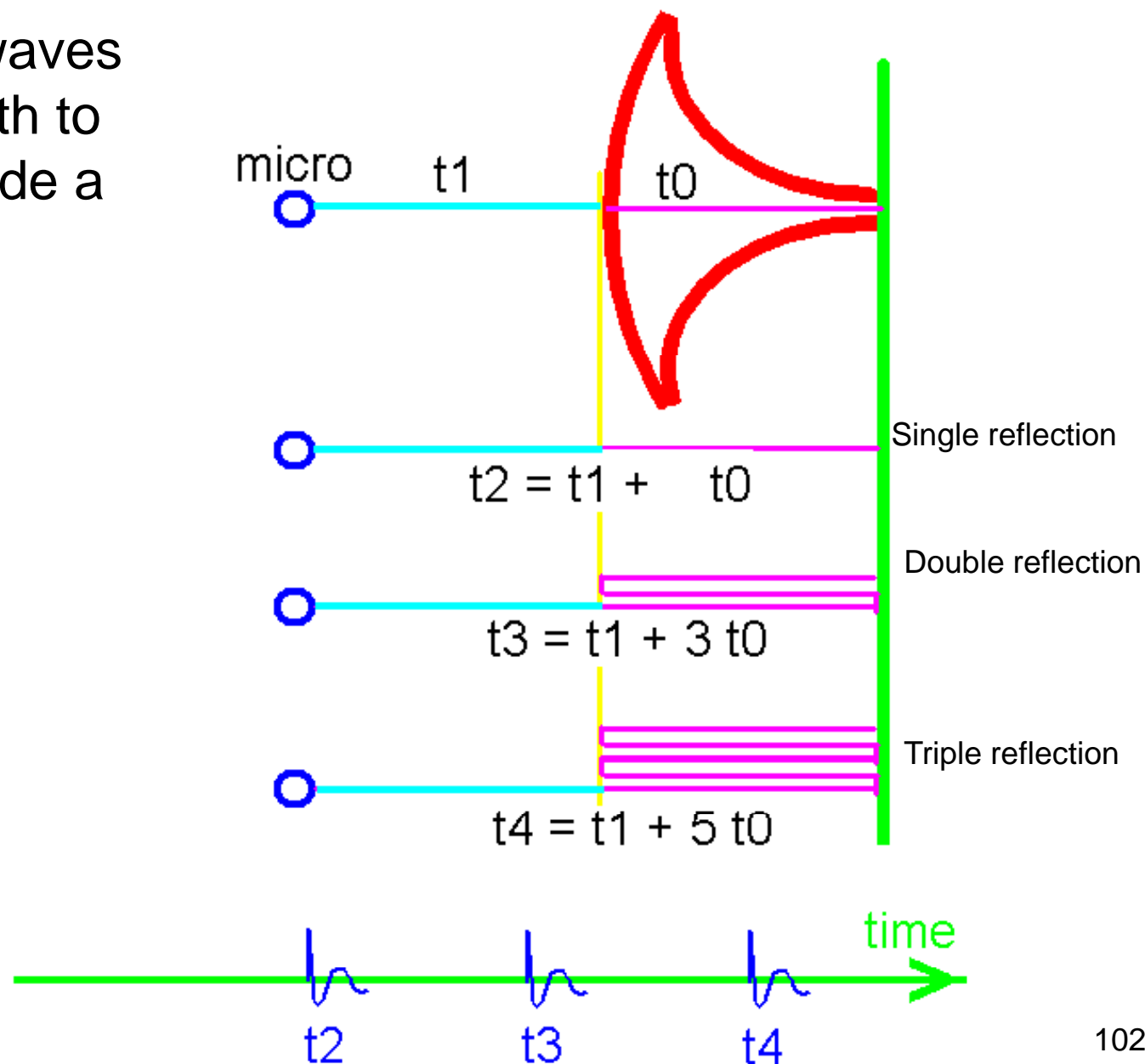
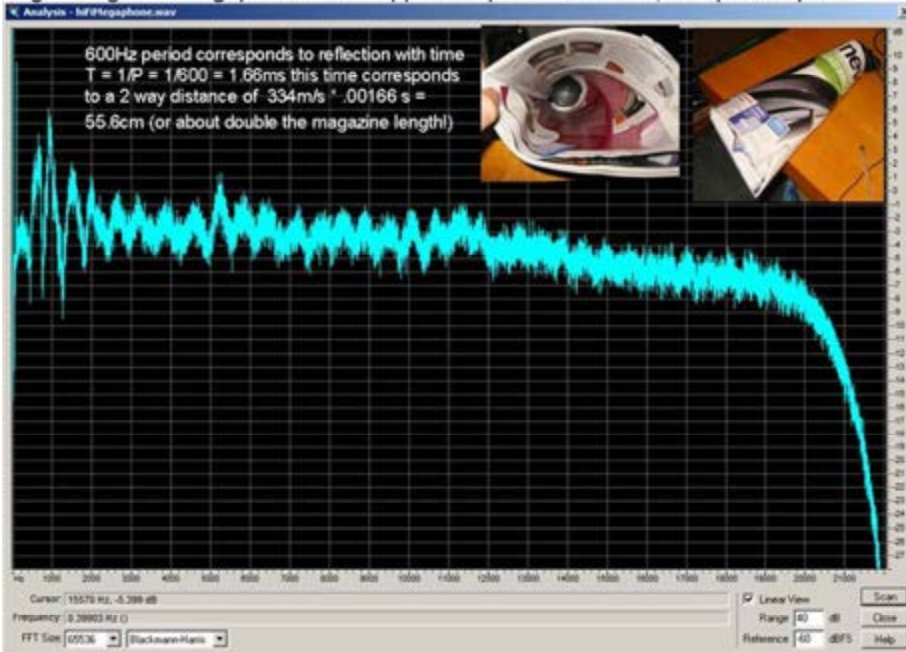

Fig 4: Magazine megaphone: Note Ripple with period of 600 Hz, 5dB peak to peak



easy demonstration of back reflected waves with a PC loudspeaker, a magazine forming a cone and a towel

When the pathlength between the direct wave and the reflected wave is equal to a multiple of the wavelength at the considered frequency, we observe a summation of their pressure.

When the pathlength between the direct wave and the reflected wave is equal to a odd multiple of the half wavelength at the considered frequency, we observe a subtraction of their pressure.

Fig 5: Magazine megaphone with peripheral towel used to damp mouth reflections

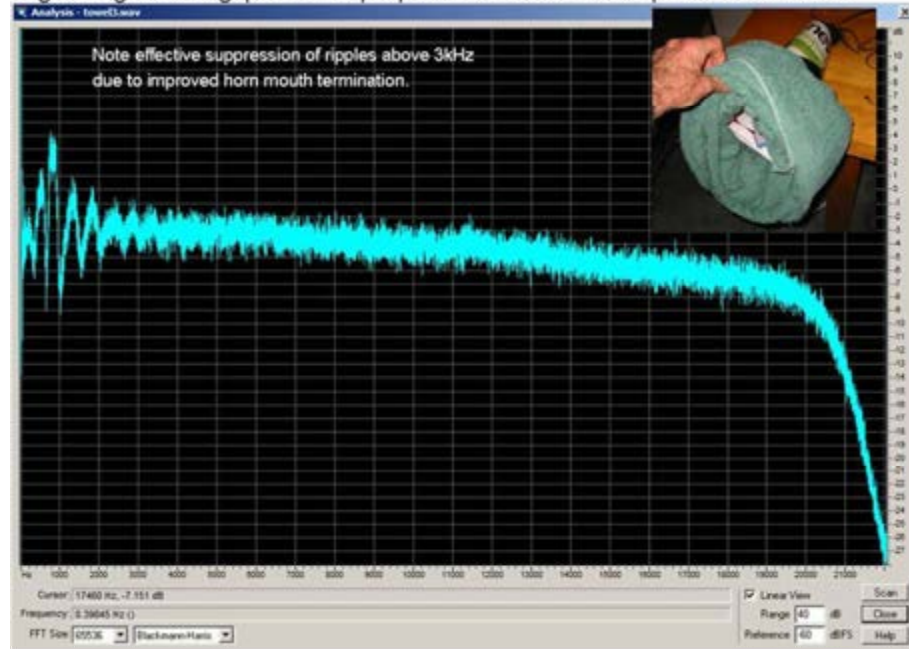

The Sound of Midrange Horns for Studio Monitors

KEITH R. HOLLAND, FRANK J. FAHY and PHILIP R. NEWELL

J. Audio Eng. Soc., Vol. 44, No. 1/2, 1996 January/February

Table 3. Horn loudspeaker samples grouped according to similarity.

Sample	Manufacturer/Type	Flare Material	Flare Rate	Length (mm)	Mouth Size
<i>Horns with similarity to reference B (Son Audax direct radiator)</i>					
1	Vitavox exponential	Aluminum	Medium	340	Medium
4	AX1 axisymmetric*	Glass-fiber	Low	230	Small
5	Reflexion Arts	Glass-fiber	Medium	330	Medium
7	Reflexion Arts, no lips	Glass-fiber	Medium	240	Medium
10	Fostex sectoral*	Wood	High	440	Large
11	JBL axisymmetric	Aluminum	Low	250	Small
<i>Horns with similarity to reference C (Fostex doctoral)</i>					
C	Fostex sectoral	Aluminum	Medium	500	Large
12	Altec sectoral*	Aluminum	Medium	530	Large
13	Altec multicellular	Aluminum	Low/med	600	Large
14	Starr gramophone	Wood	Low	650	Medium
15	Vitavox sectoral	Aluminum	Medium	450	Large
16	JBL biradial*	Composite	Medium	400	Medium
<i>Others</i>					
8	AX2 axisymmetric	Glass-fiber	High	230	Medium
9	Yamaha sectoral	Aluminum	Medium	350	Medium

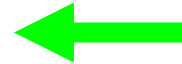
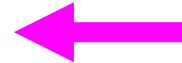

Sample 8: AX2 horn/Emilar EK175 driver (no. 1). Short axisymmetric horn of glass-fiber construction with a rapid flare rate terminating in a medium-sized mouth. Compression driver as sample 1.

Sample 13: Altec 806C horn/Emilar EK175 driver (no. 1). Large multicellular horn with eight individual flares of sheet aluminum construction joined to a single throat via a cast aluminum manifold. Compression driver as sample 1.

- Horns do sound different from each other, even when fitted with the same driver.
- The two horns having minimal mouth reflections, one long and one short, were not identified as horns and did not sound similar to the direct-radiating reference.

the two horns in the test that produce negligible mouth reflections, samples 8 and 13, neither was ever identified as a horn, and the short horn, sample 8, did not sound like the direct-radiating reference B.

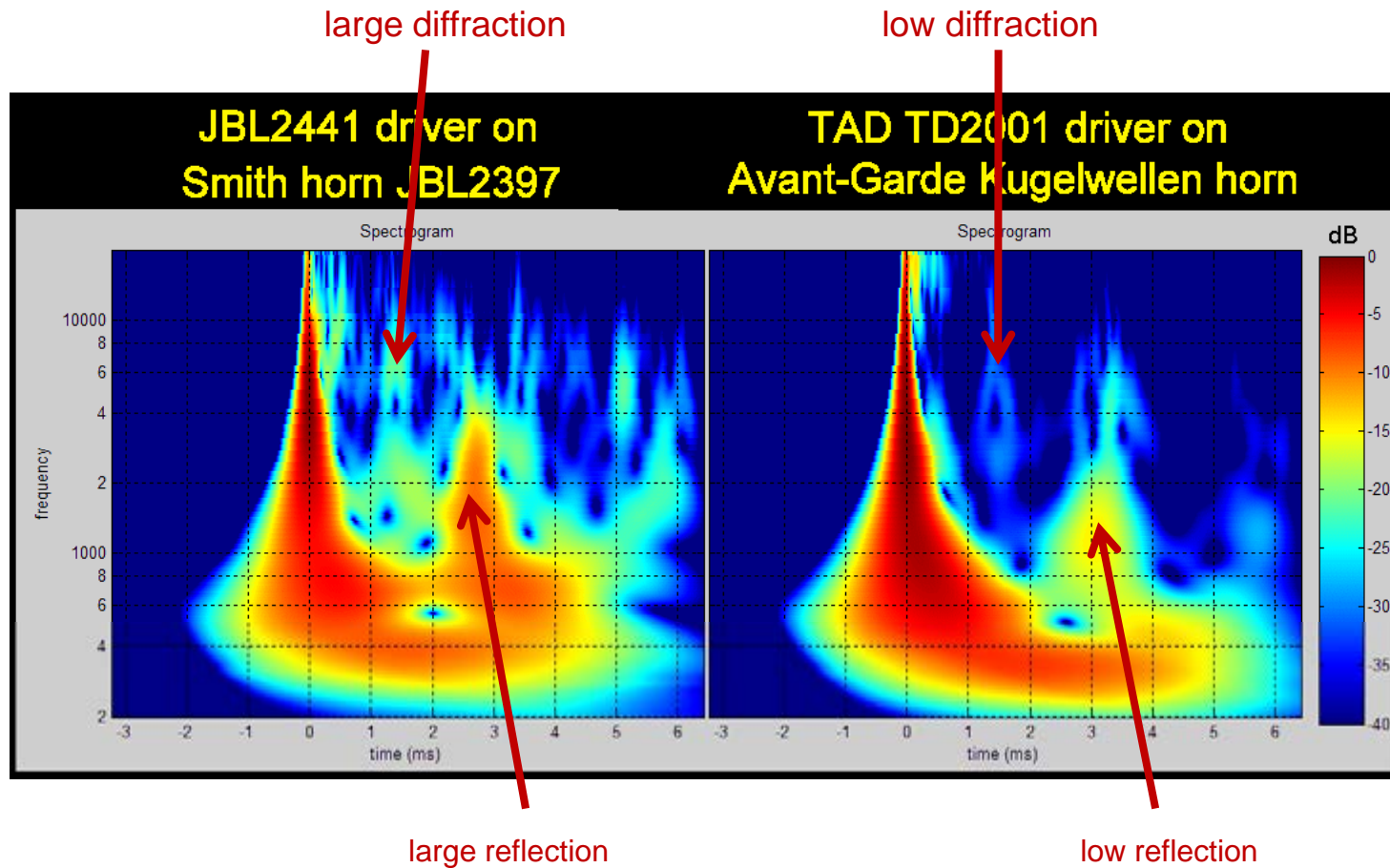

Compared wavelets graphs of 2 horns:

- on left, high reflectance
- on right very low reflectance

*measurements
performed at ETF2010*

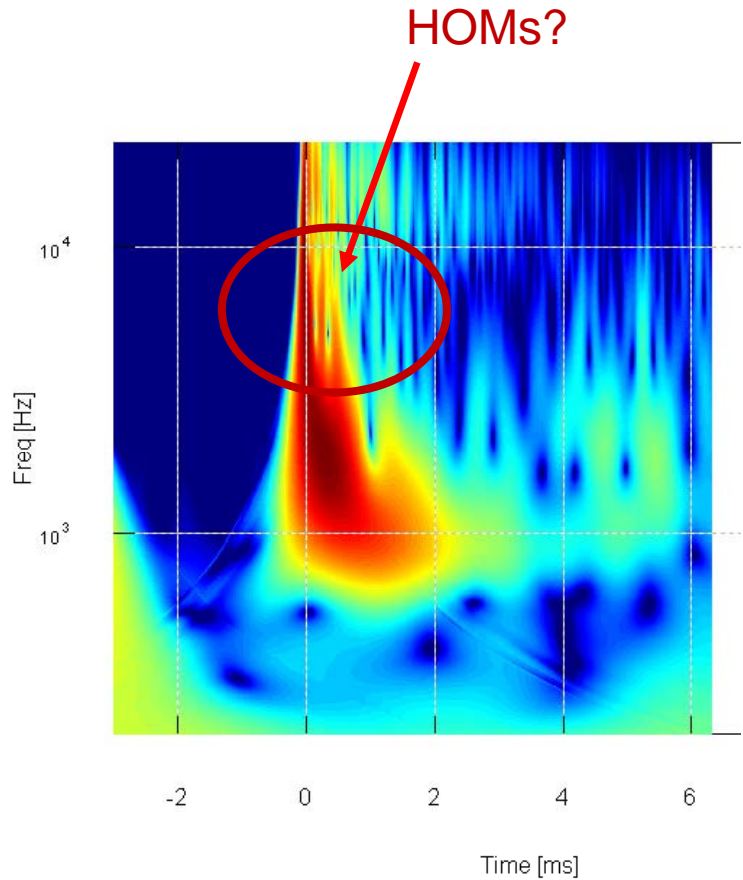

wavelets graph of the oblate spheroidal waveguide

HOMs absorption

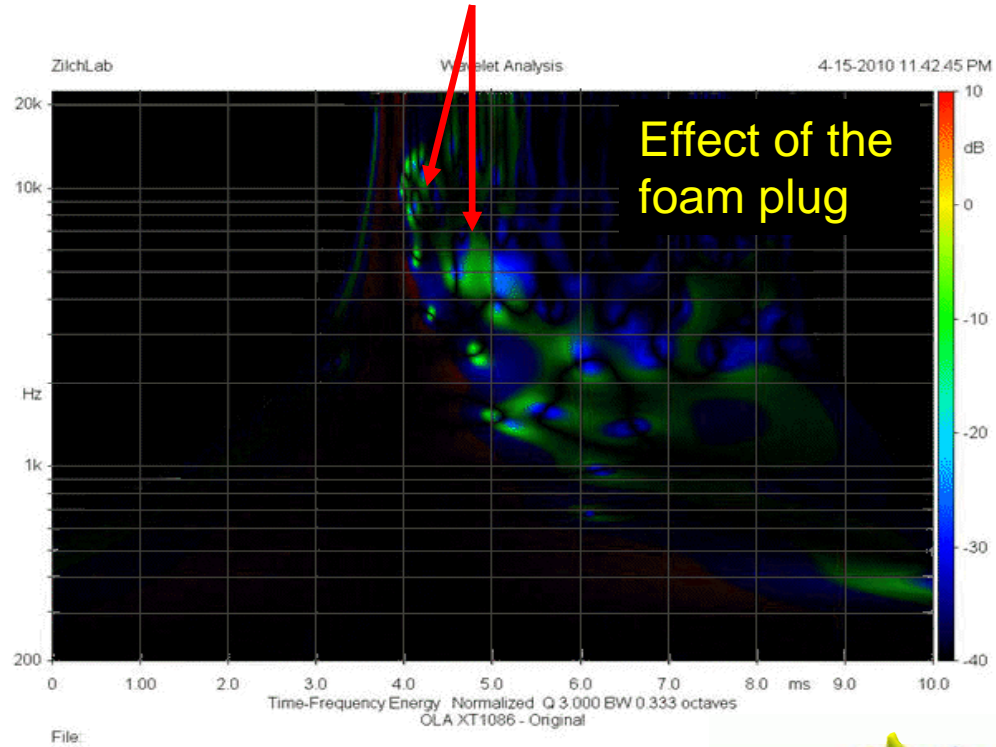

subtraction of the wavelets graph of the OSWGD without its foam plug and with its foam plug

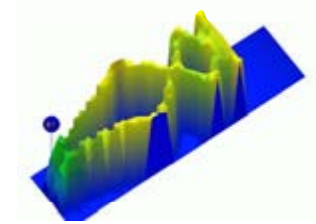

HOMs have non axial travel inside the horn

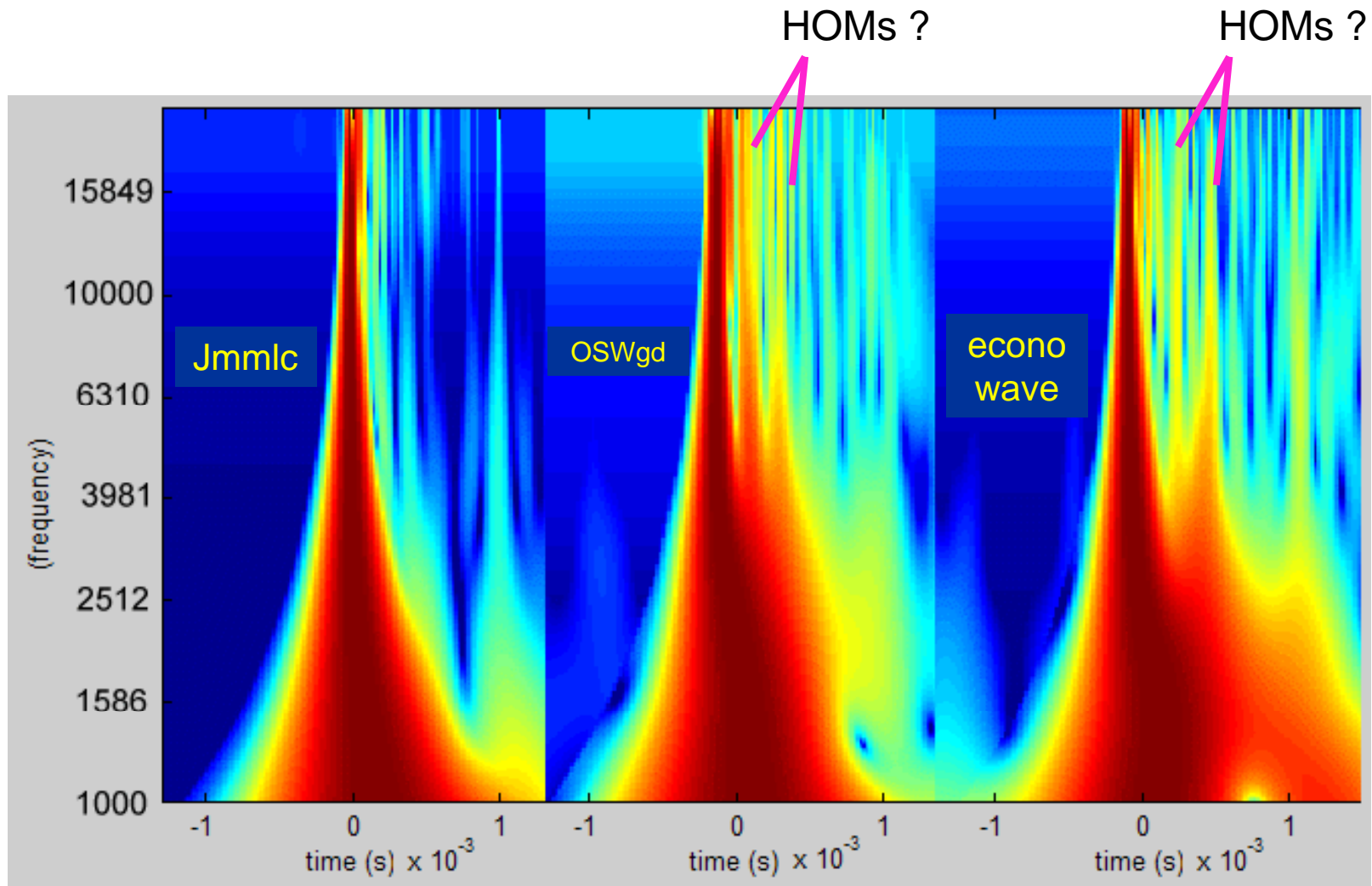

the wavelets graph may be used in order to show the existence of sub-millisecond delayed energy (HOMs?)

optimization with the goal
of a low reflectance

Electro-Voice DH1A horn driver

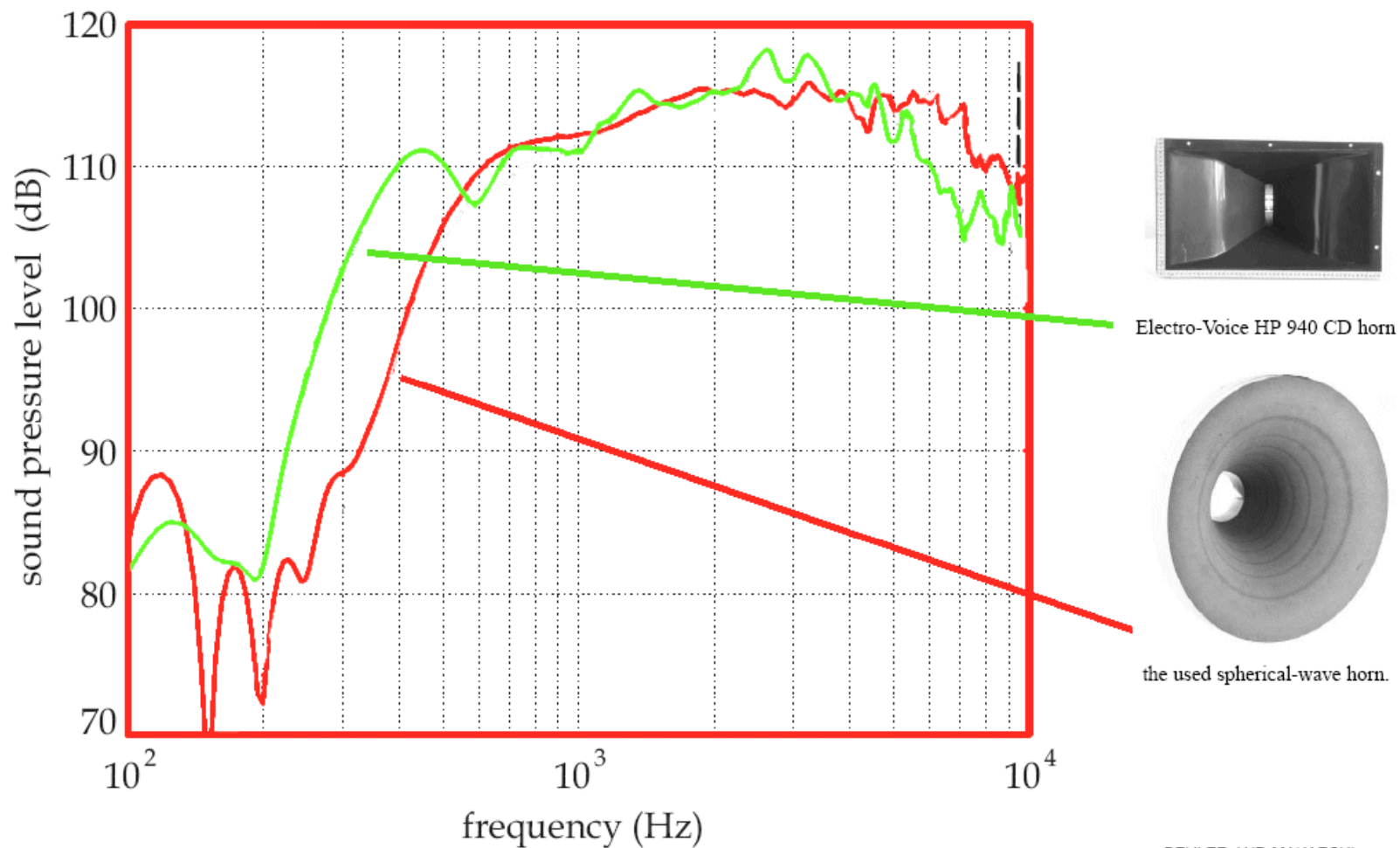

horns having a lower reflectance at mouth have smoother frequency response curves

BEHLER AND MAKARSKI
J. Audio Eng. Soc., Vol. 51, No. 10, 2003 October

Shape optimization of an acoustic horn

Erik Bångtsson, Daniel Noreland, and Martin Berggren

May 8, 2002

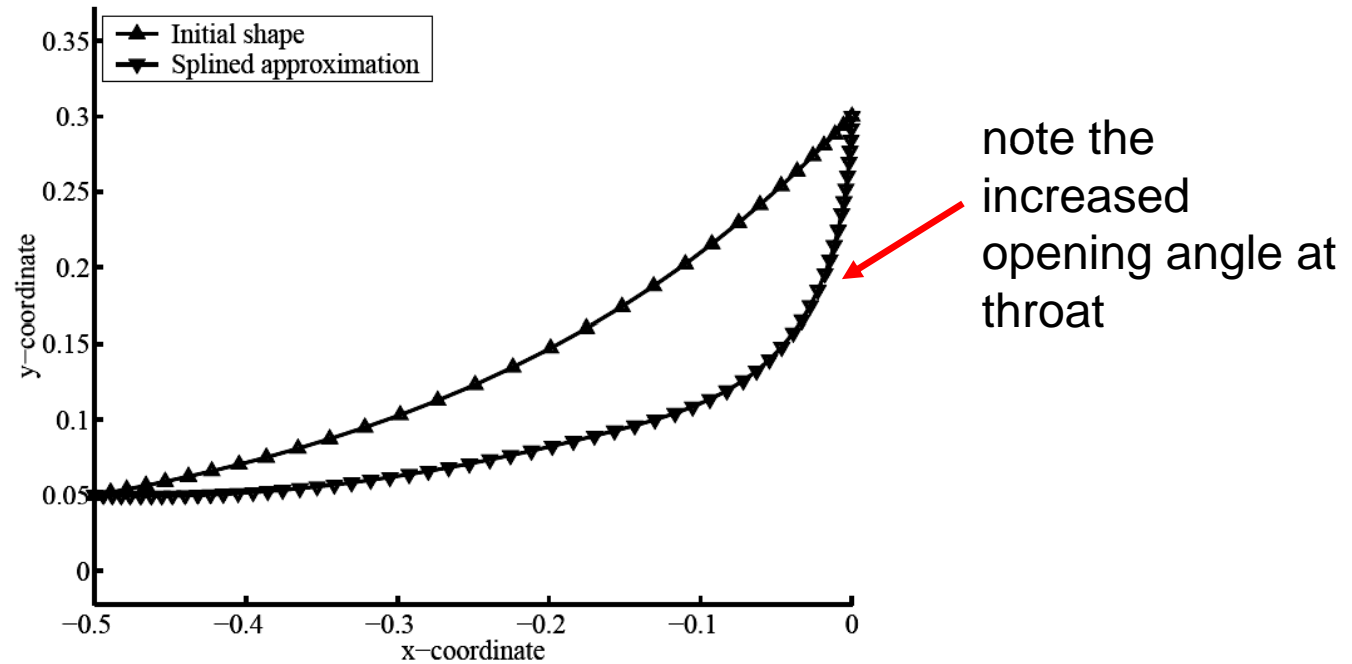

The initial shape and the splined approximation of the optimal shape from the 27 frequency optimization shown in figure 18.

optimized profile for the lowest reflectance at 27 frequencies

In search of a more constant radiation angle

The problem of directivity

- Multicellular horns
- Multisectorial horns
- Constant directivity horns
- Waveguides

Quadratic throat waveguide

Oblate spheroidal waveguide

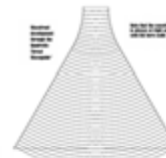
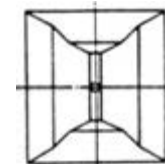
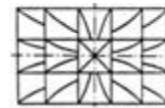

multicellular horns

- with curved dividers
- with identical cells

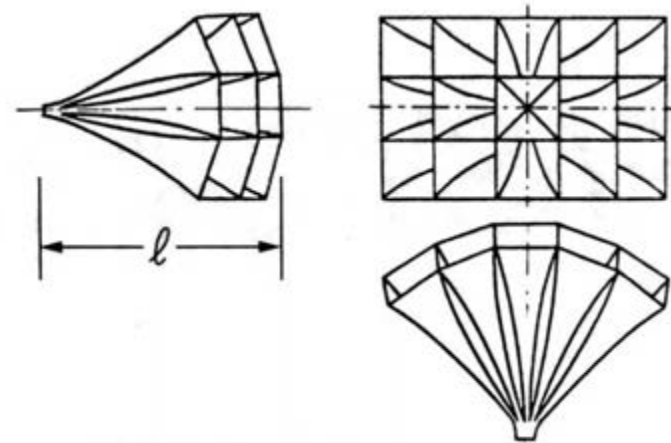

the idea is to split the wavefront near the throat of the horn through several ducts before the wavefront at HF begins to separate from the walls of the horn.

multicellular horns with curved thin dividers

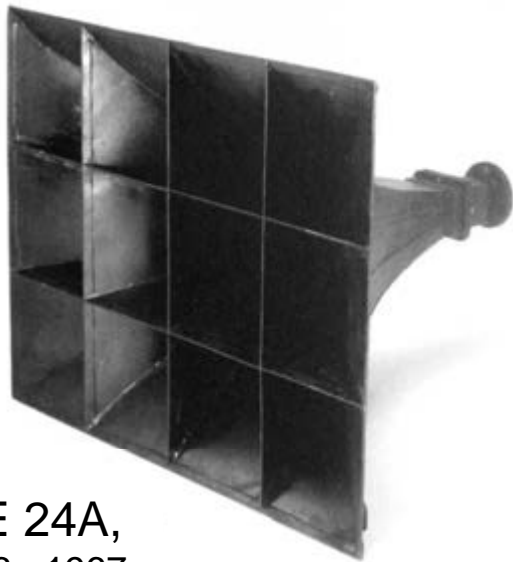

WE 24A,
1936 - 1967

The dividers follow « flow lines ».
Different shapes of cell coexist.
Flat mouth

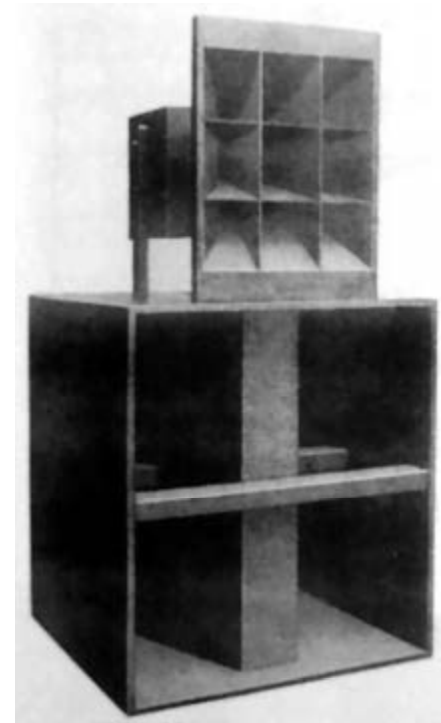

multicellular horns with identical cells

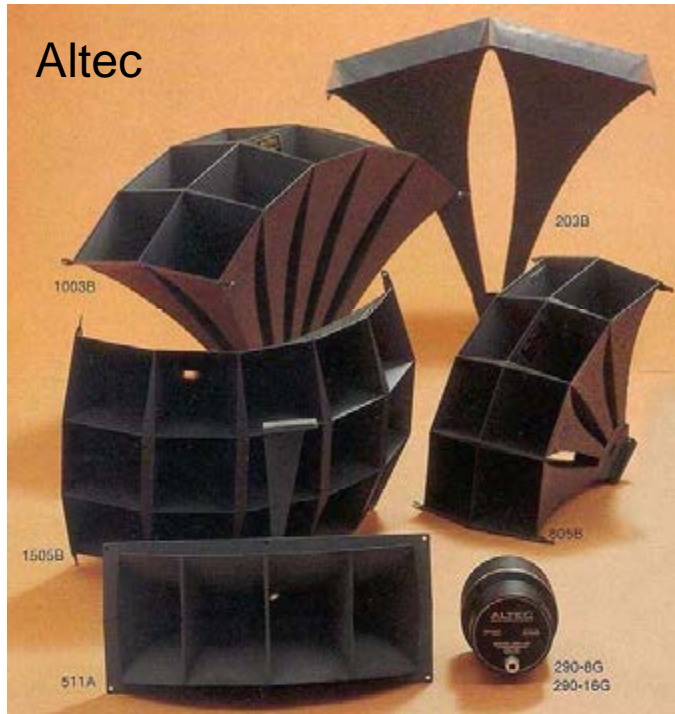

Onken 255wood



Altec Lansing
H1804B



Onken 255 wood and Onken 455
wood horns on top of an Onken W
bass reflex enclosure



26A HORN

USE - STAGE HIGH FREQUENCY
 DESCRIPTION - SPHERICAL FACED, 12 CELL, EXPONENTIAL, 3 X 5, ERPI
 LAMINATED METAL, BLACK
 APPLICATION - USED WITH 1 22A RECVR. ATTACH. & 1 594A LOUDSPR. OR WITH
 1 22B RECVR. ATTACH. & 2 LOUDSPEAKERS IN MICROPHONIC SYSTEMS
 DIMENSIONS - 25 INCHES HIGH X 37 INCHES WIDE X 32.5 INCHES DEEP
 WEIGHT - 125 POUNDS WITH ONE RECEIVER, 150 POUNDS WITH TWO RECEIVERS
 FREQUENCY RESPONSE - 100 CYCLES TO 8000 CYCLES/SECOND
 HOR. COVERAGE - 110 DEGREES
 VERT. COVERAGE - 40 DEGREES
 COVERS AUDITORIUM WIDTH OF 75 - 120 FEET

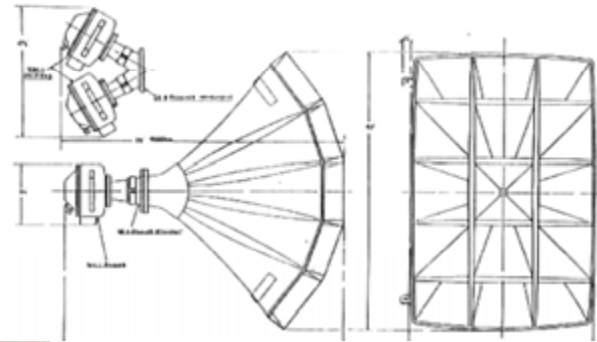

detail of
 the assembly
 of cells



sectorial horns

- sectorial horns have linear (« conical ») expansion in one plane and exponential expansion in the other.
- Dividers can be flat (e.g. Altec 511 and 811) or not (e.g. JBL Smith horn JBL2397)

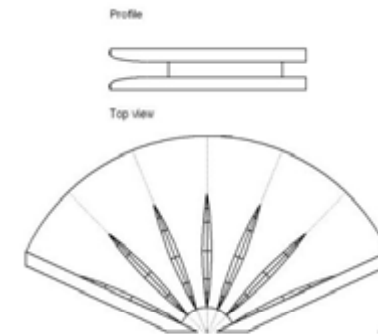

**ALTEC
LANSING**

**311-60 AND 311-90
SECTORAL HORNS**



Onken 500



311-60



311-90

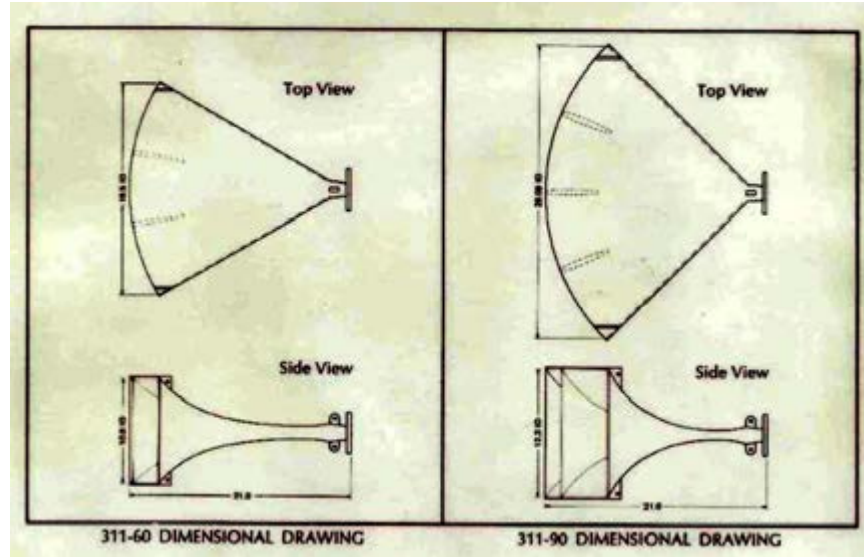

311-60 DIMENSIONAL DRAWING

311-90 DIMENSIONAL DRAWING

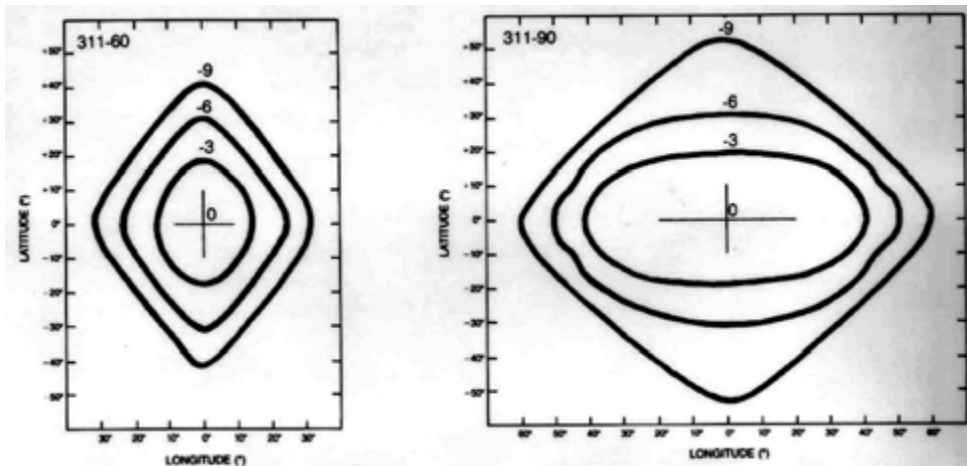

2. Sound Level Contours in dB

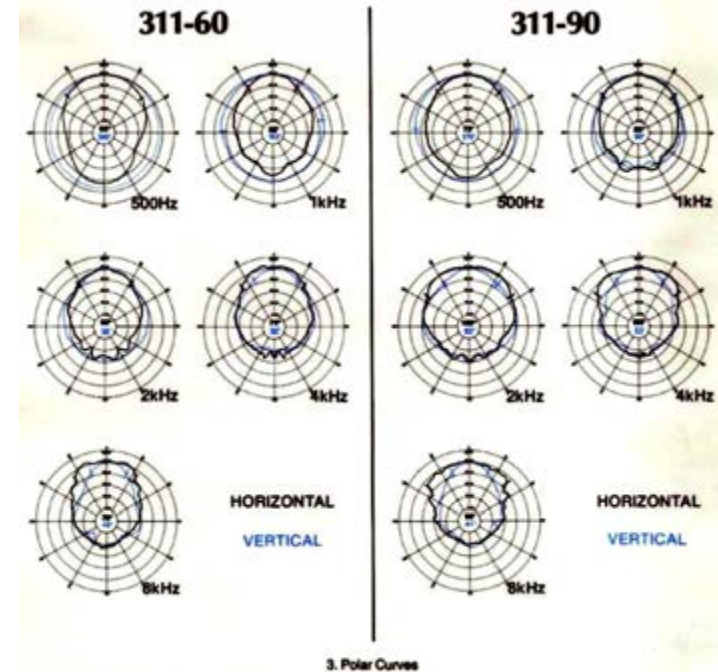

3. Polar Curves

Smith horn and related

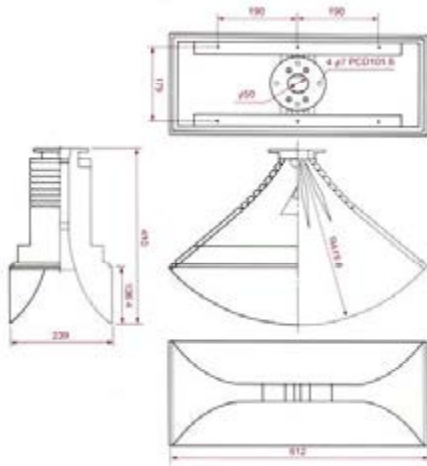

The TAD TH4001 horn has a Smith horn design at throat



Yuichi Arai's A300 horn

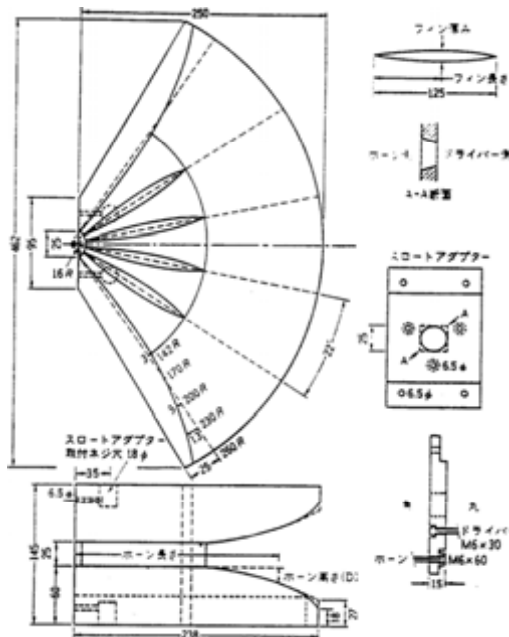

Fig. 1. The Smith-Selsted tweeter unit in combination with a more conventional h-f speaker and a woofer cabinet.

A Loudspeaker for the Range from 5 to 20 kc

B. H. SMITH* and W. T. SELSTED**

In response to many requests for a description of the unit mentioned in the August issue, the authors provide full design information on this remarkable speaker.



JBL2397

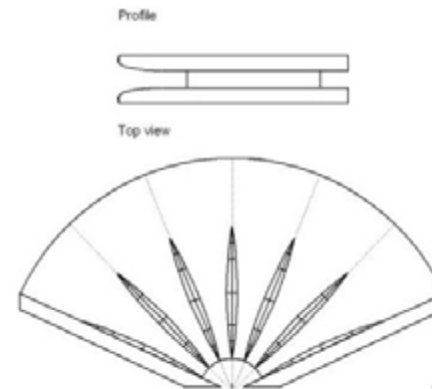

2. The sum of the velocities around any closed loop is zero.

Since the fundamental equations and the combining rules of the two systems are identical, it follows that the solutions of these equations may be obtained by identical means. A schematic diagram for the mechanical circuit may be drawn, and a solution may be obtained just as it is done for electrical circuits. For example, consider the mechanical circuit of (A) in Fig. 3. The schematic diagram and solution are shown at (B).

The quantity Z_m is the mechanical quantity analogous to electrical impedance. Firestone calls this the bary-impedance. Before Firestone introduced his force-current analogy, mechanical impedance had already been defined as the ratio of force to velocity. Thus, the ac-impedance is the reciprocal of the conventional mechanical impedance.

Equivalent Circuit for Horn

We shall now proceed to develop the equivalent circuit of a horn type loudspeaker. As current flows through the

$$i = \frac{V}{Z}$$

current (to a voltage V), capacitance C opposes to i , inductance L opposes to i , resistance R opposes to i . The equations of the same form, combining these. For the elements are known as a are:



Fig. 2. The tweeter resembles an ordinary high-frequency speaker except for the relatively large field coil housing.



Altec

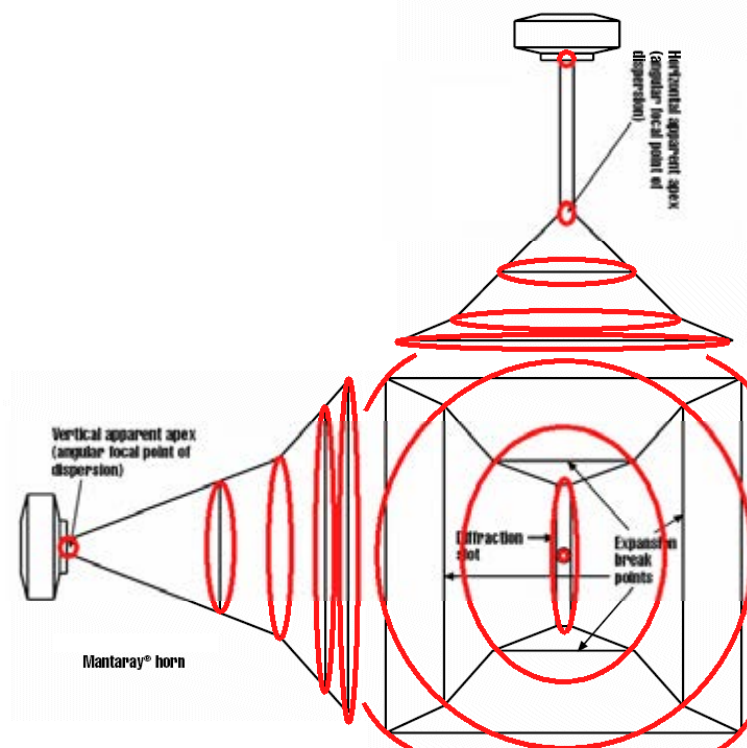
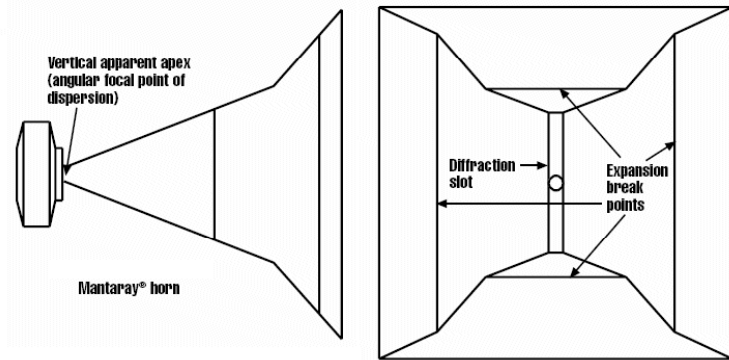
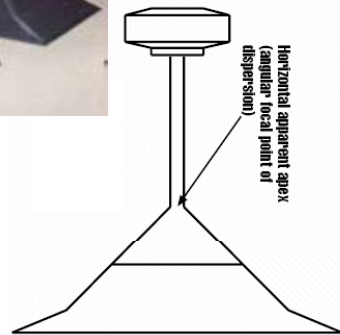

diffraction zones in red

the Mantaray horn

from diffraction horns to biradial horns

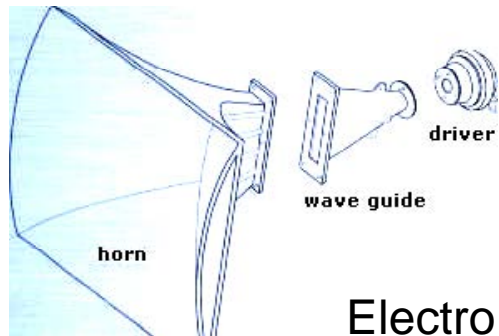

Electro Voice



Jim Long and Don Keele in Jim's living room standing on either side of the right-channel HR-9040 "constant directivity" horn mounted over the bass horn designed by Ray Newman. Sept. 2004.

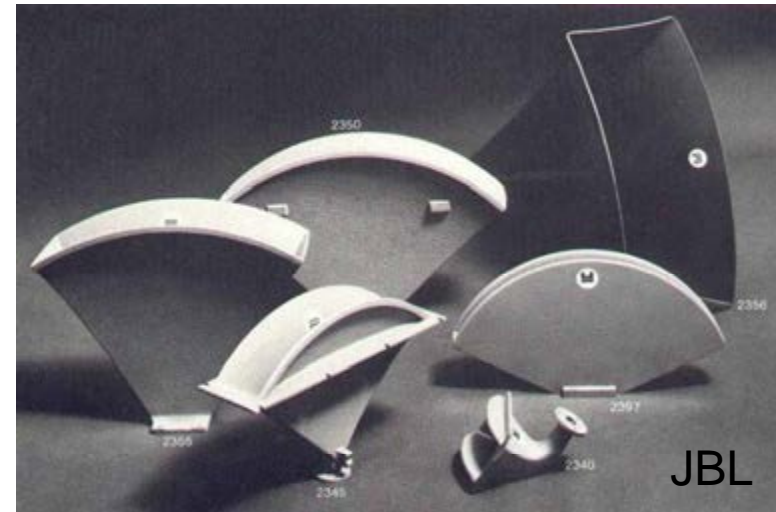

Directivity control

its goal:

to obtain a more constant
frequency response over a
chosen solid angle

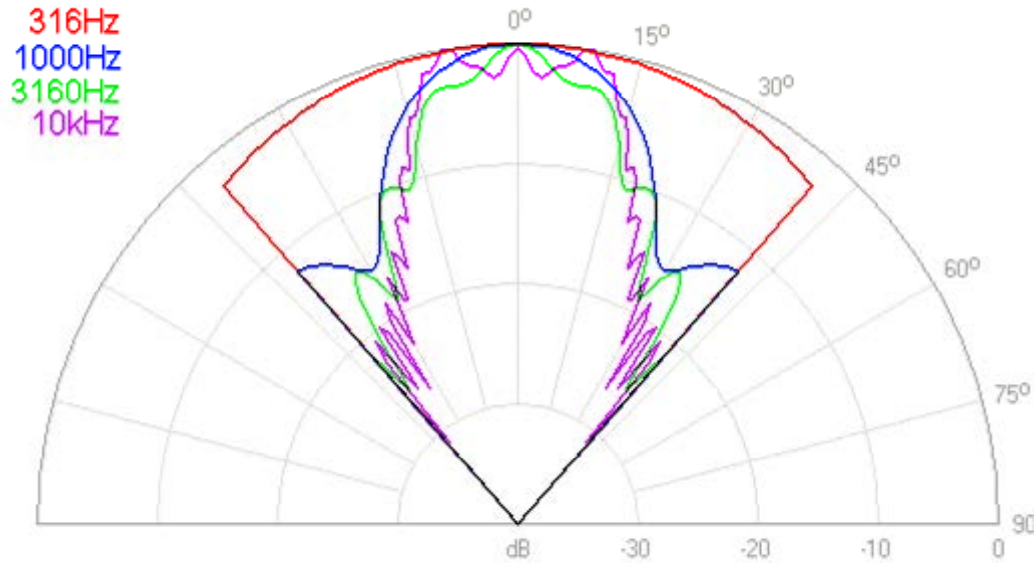

Oblate spheroidal waveguide

Note the rather constant directivity over 1kHz and the wavy contours

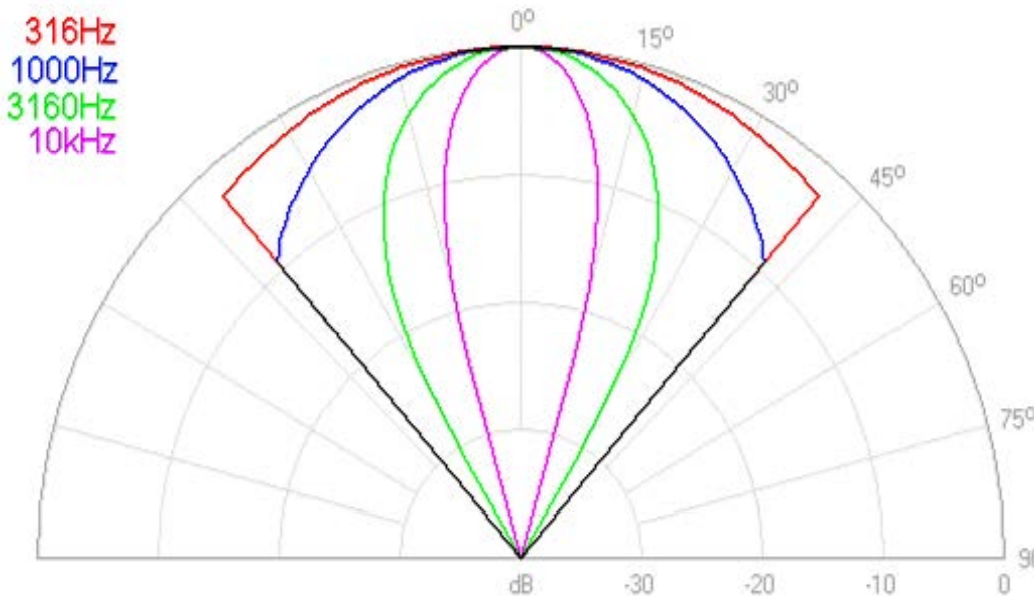

horn calculated by the "Le Cléac'h" method

Note the directivity regularly increasing with frequency and the smooth contours

*simulations using
Hornresp*

Earl Geddes's « Summa Cum Laudae » 2 ways enclosure

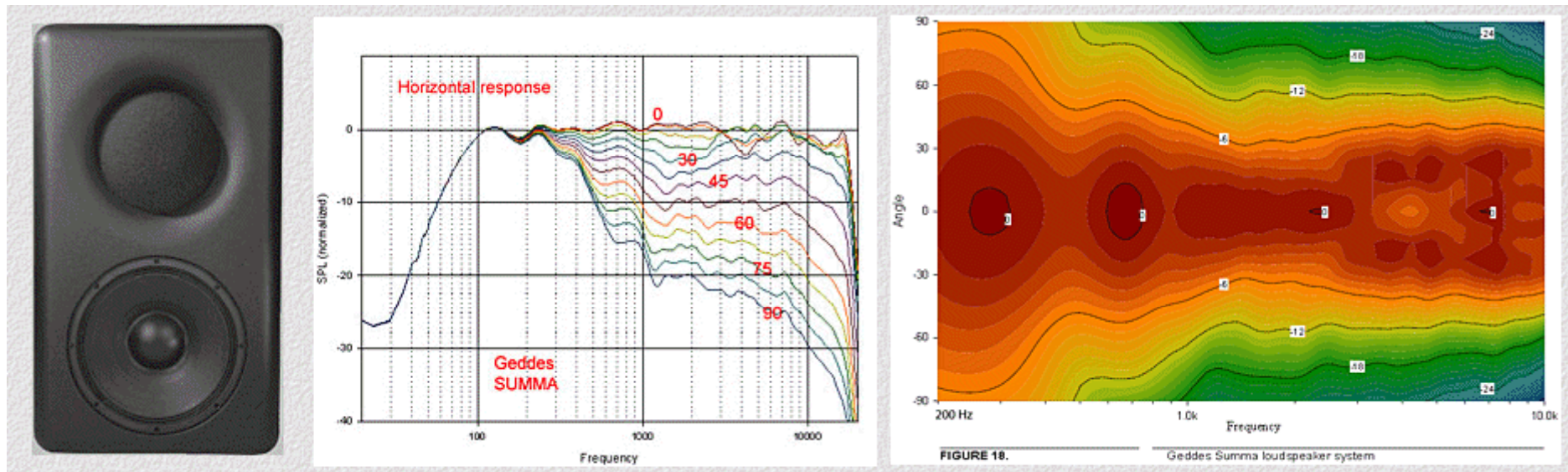

See also:

**Acoustic waveguide for controlled
sound radiation**

United States Patent 7068805



Earl Geddes

TOOLS FOR THE PROFESSIONAL DEVELOPMENT OF HORN LOUDSPEAKERS

Diplom-Ingenieur
Michael Makarski
aus Mainz

20. April 2006

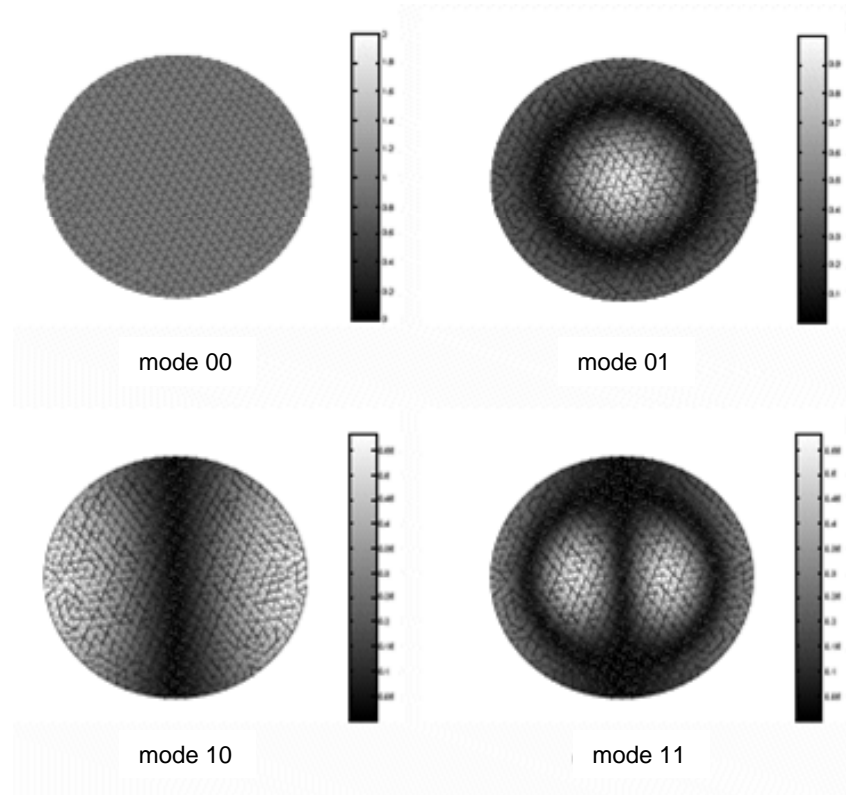

only modes 00, 0i, j0
exist with round horns

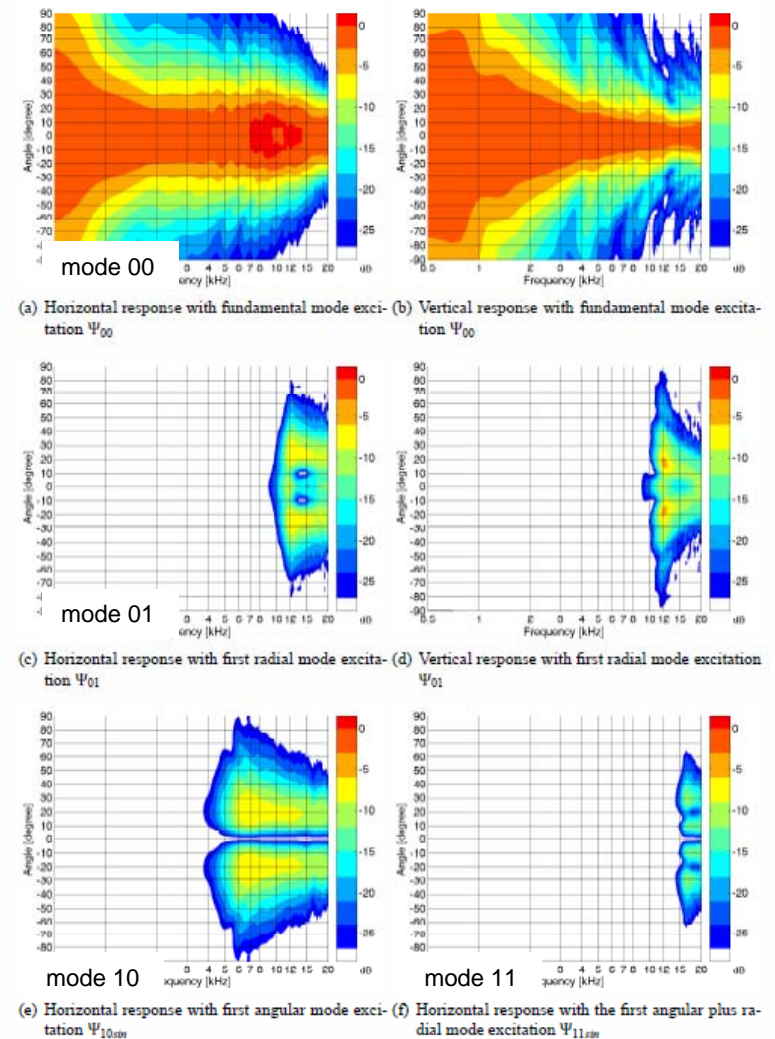
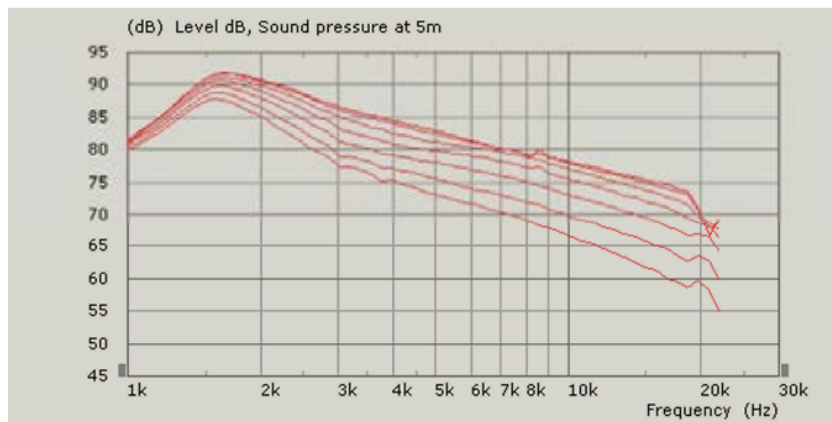
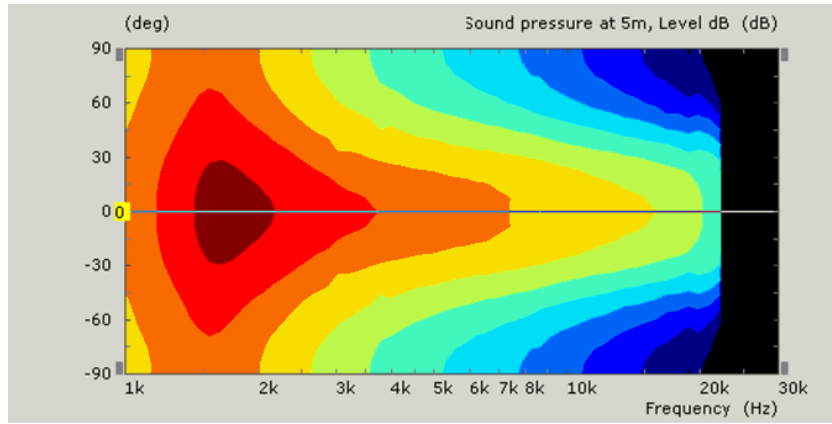
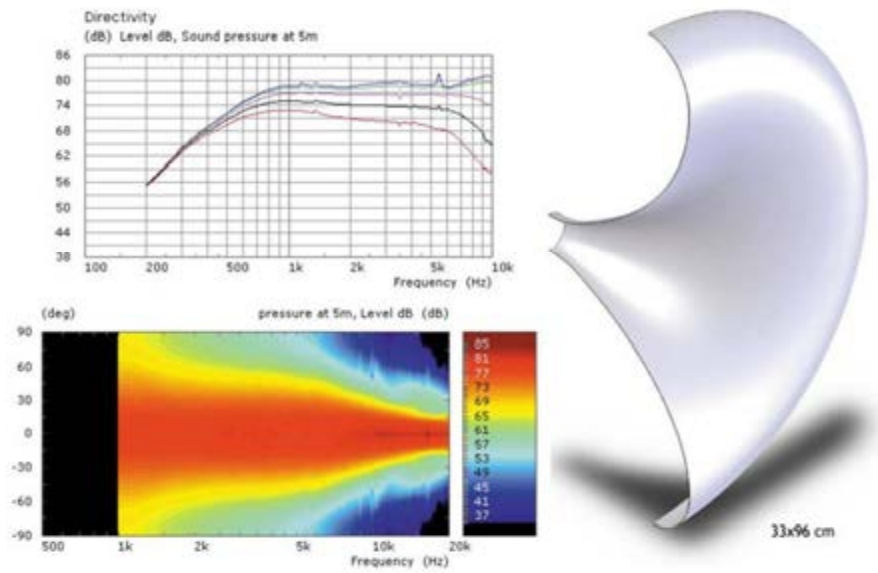

Figure 5.12: Modal directivity responses normalized to the 0° frequency response of the fundamental mode

each High Order Mode has its own cut-off frequency



Minimum phase horns (or short Minphase) by ing. Michael Gerstgrasser. This are state-of-the-art Gauss optimized horns that offer smoothest sound field with controlled directivity (CD) and good look. Above example with a flat 3" diaphragm.

Michael Gerstgrasser's min phase horn is a good compromise between the Le Cléac'h horn and the OS Waveguide

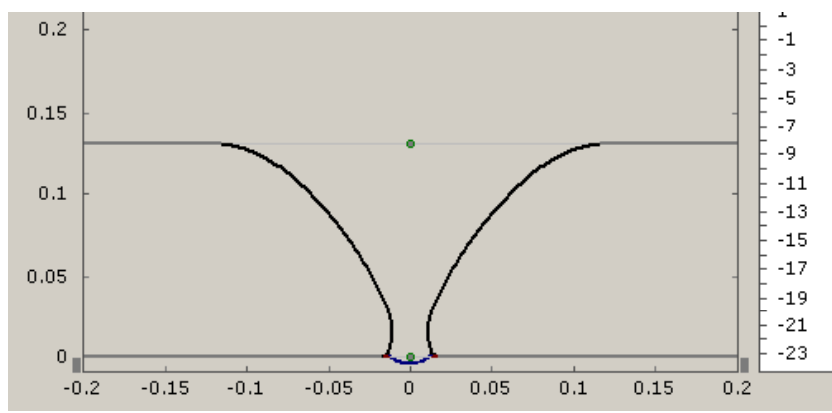

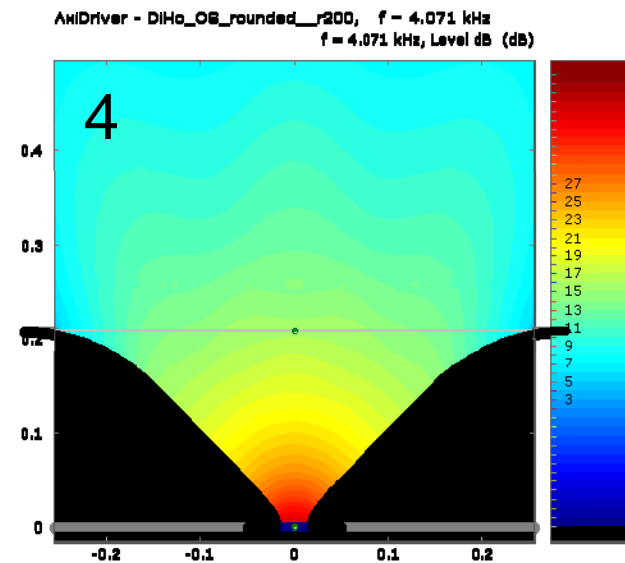
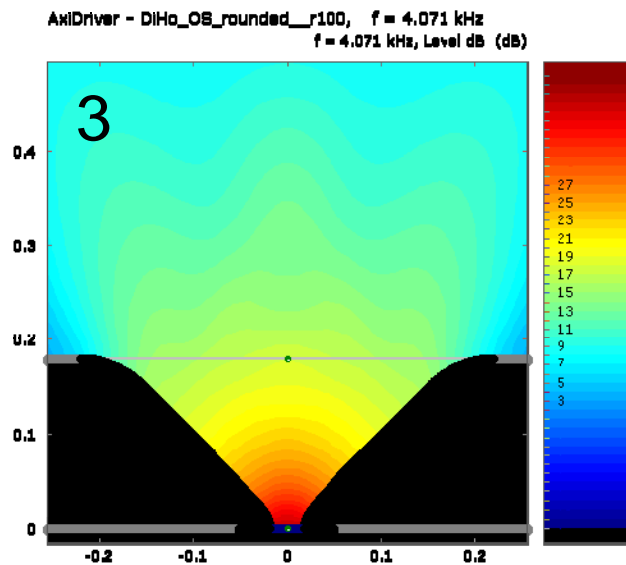
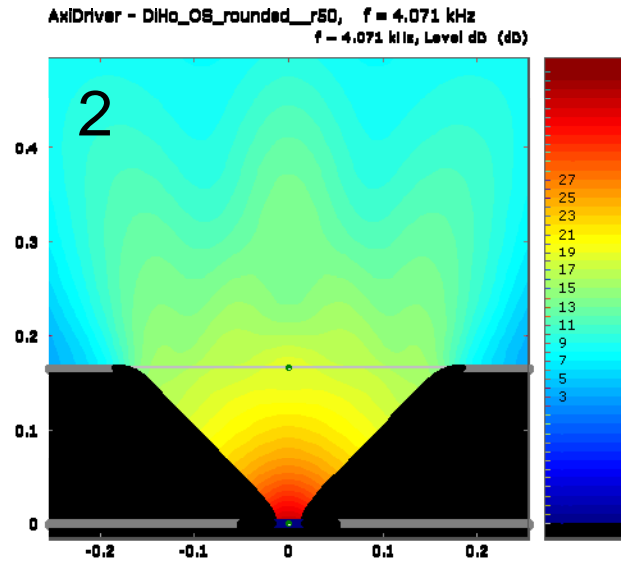
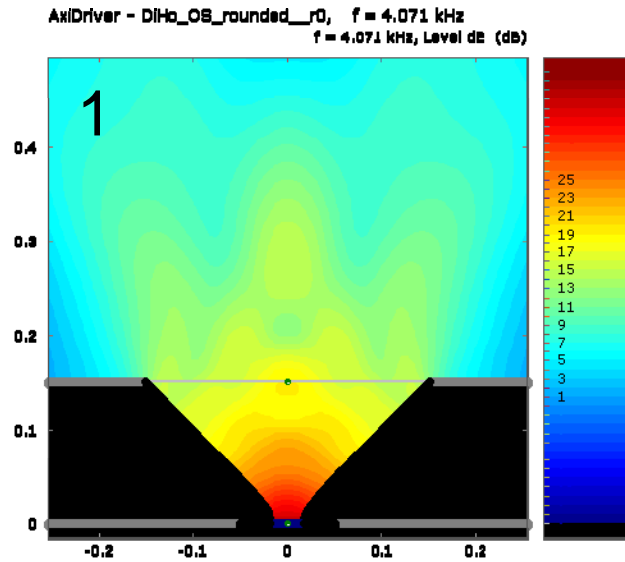

from 1 to 4 the profile of the mouth of an OS waveguide is curved at a nearer distance from the throat



simulations performed by Michael Gerstgrasser using AxiDriver

from 1 to 4, note the more evenly distributed pressure field

frequency response from 0° on axis to 90° off axis by 5° steps

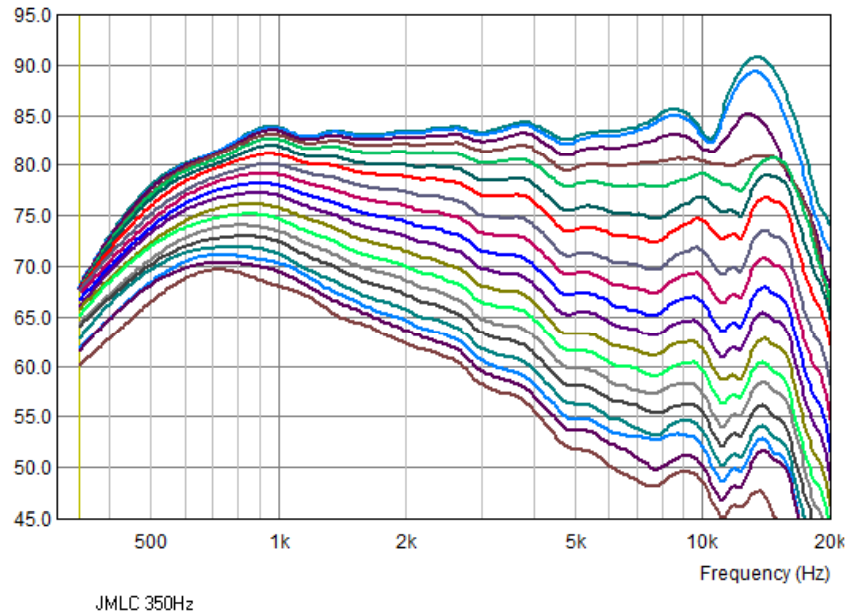

without equalization

Le Cléac'h horn

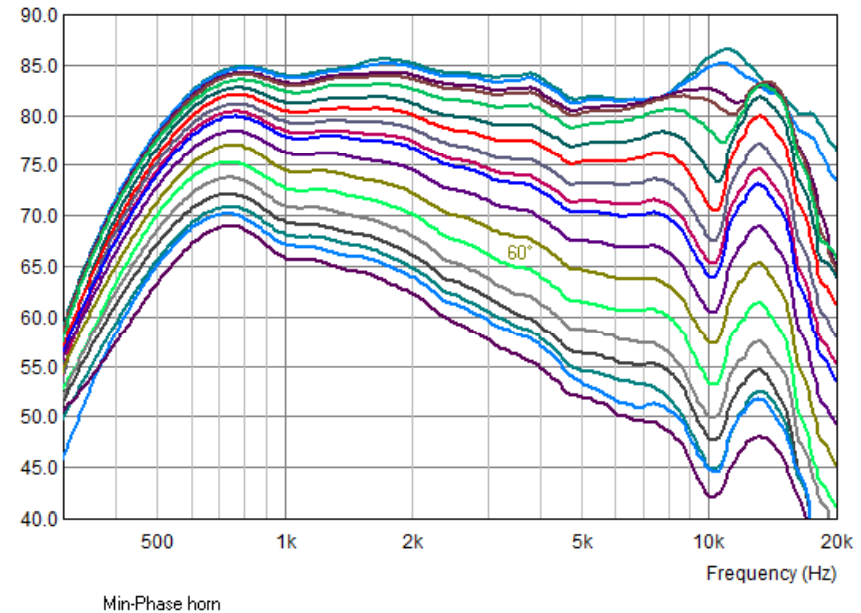

with equalization

Min-Phase horn

The Min-Phase horn provides a better directivity control than the Le Cléac'h horn while keeping the smoothness of the frequency response curves on and off axis.

the END

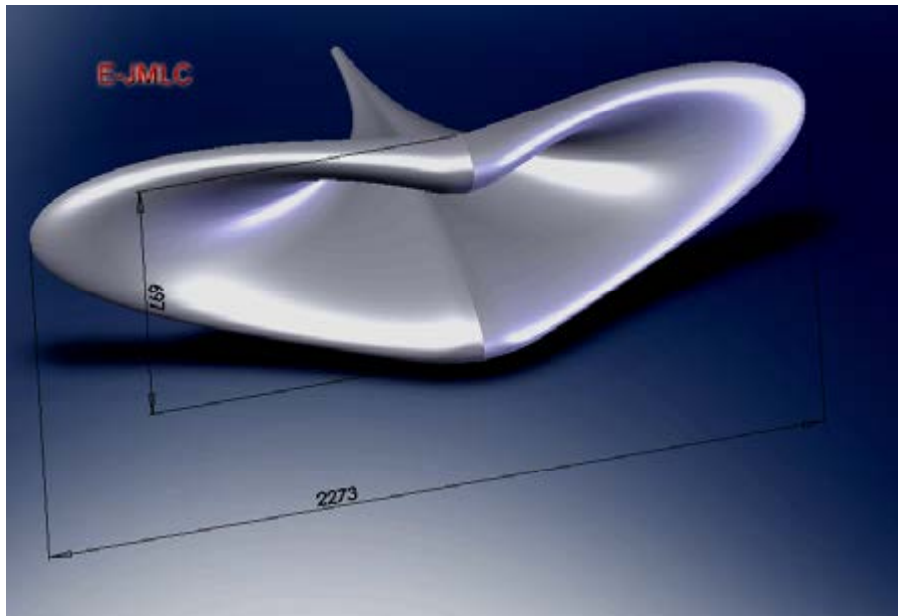

a new Le Cléac'h horn (2007)

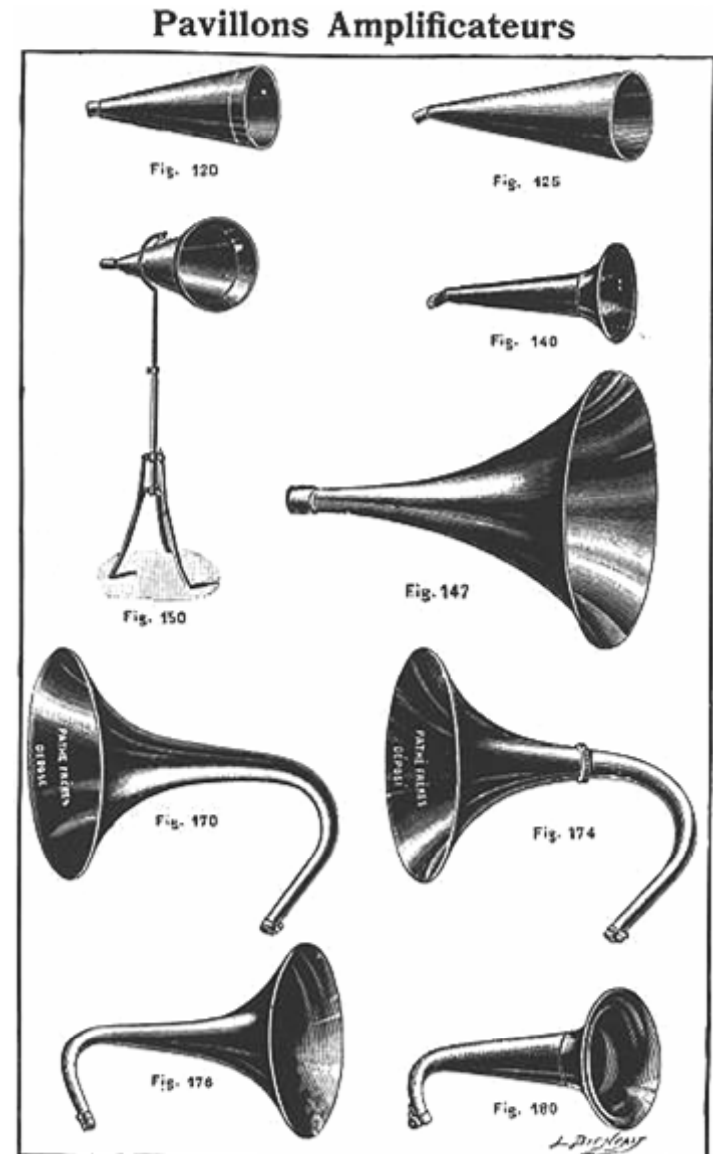

horns commercialized by Pathé (France), 1903